

# Boiserie / Testiere a parete / Sommier

*Wall panels / Wall mounted headboard / Sommier*

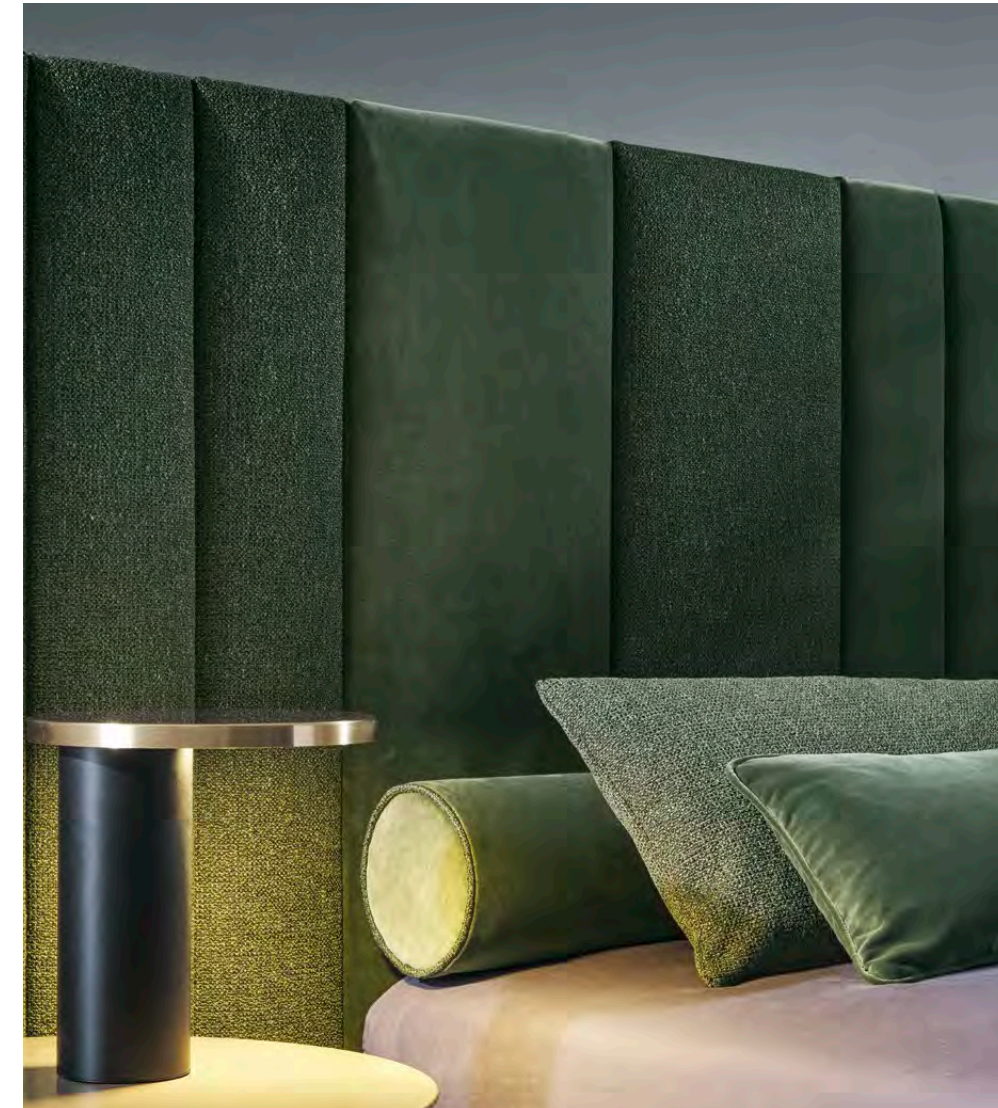

Boiserie / Testiere a  
parete / Sommier  
Wall panels / Wall mounted  
headboard / Sommier



**Pannello soft non abbinabile a pannello liscio.**  
Soft panel cannot be matched with smooth panel.

**Boiserie Marlene, un modo originale e fantastico per arredare qualsiasi parete della stanza da letto. Tre finiture, liscia, soft e capitonné un montaggio semplice e veloce. Interscambiabilità e modularità, sono solo alcune caratteristiche che rendono questo prodotto una soluzione ideale e innovativa per l'arredamento classico o moderno.**

*Boiserie Marlene, a fantastic and truly original way to dress any wall in your bedroom. The upholstered panels come in three finishes, smooth, soft and button tufting, and are quick and easy to fix. They are interchangeable and modular, just two of the many qualities which make this product an ideal and innovative solution in any classic or modern environment.*

- Caratteristiche:**
- Due misure: 97,5x38 e 65x38
  - Spessore cm 5
  - Pannelli sfoderabili (pelle esclusa e Capitonné)
  - Tre lavorazioni: Liscia, Soft, Capitonné realizzabili con tutti i tessuti del campionario.

**Si consiglia nella lavorazione Capitonné di utilizzare solo pelle o similpelle data la non sfoderabilità dell'articolo.**

- Features:**
- Two sizes: 97.5x38 and 65x38
  - Thickness 5 cm
  - Removable (excluding leather and capitonné)
  - Three finishes: smooth, soft, capitonné, available with all the fabrics in the swatch samples.
- If choosing the capitonné option, we recommend using only leather or synthetic leather as the Coverings cannot be removed*

**Pannello liscio**  
Smooth panel

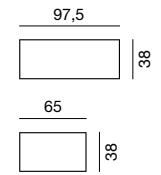

Dimensioni Size	Codice Code	H.L.P.	Tessuti - Fabrics				Pelle - Leather			Tessuto cliente L./H. C.O.M. fabric L./H.	m <sup>2</sup>	kg
			Cat. B	Cat. C/D	Cat. Must	Cat. K	Cat. E	Cat. Plus	Cat. Luxury			
97,5	281097038	38x97,5x5								1,30x2/1,40	0,04	7
65	281065038	38x65x5								0,92x2/1,40	0,02	4

**Pannello soft**  
Soft Panel

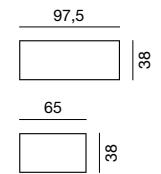

Dimensioni Size	Codice Code	H.L.P.	Tessuti - Fabrics				Pelle - Leather			Tessuto cliente L./H. C.O.M. fabric L./H.	m <sup>2</sup>	kg
			Cat. B	Cat. C/D	Cat. Must	Cat. K	Cat. E	Cat. Plus	Cat. Luxury			
97,5	27S097038	38x97,5x5								1,15x2/1,40	0,04	5
65	27S065038	38x65x5								0,78x2/1,40	0,02	4

**Pannello Capitonné**  
Capitonné Panel

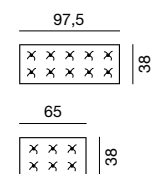

Dimensioni Size	Codice Code	H.L.P.	Tessuti - Fabrics				Pelle - Leather			Tessuto cliente L./H. C.O.M. fabric L./H.	m <sup>2</sup>	kg
			Cat. B	Cat. C/D	Cat. Must	Cat. K	Cat. E	Cat. Plus	Cat. Luxury			
97,5	282097038	38x97,5x5								0,75x2/1,40	0,04	7
65	282065038	38x65x5								0,53x2/1,40	0,02	4

**Esempi di composizioni**  
Examples of compositions

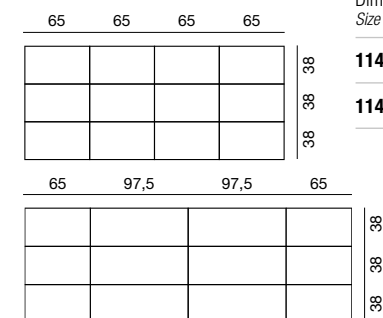

Dimensioni Size	Codice Code	H.L.P.	Tessuti - Fabrics				Pelle - Leather			Tessuto cliente L./H. C.O.M. fabric L./H.	m <sup>2</sup>	kg
			Cat. B	Cat. C/D	Cat. Must	Cat. K	Cat. E	Cat. Plus	Cat. Luxury			
114x260		114x260x5								1,30x2/1,40		
114x325		114x325x5								1,30x2/1,40		

**Mensola rivestita in pelle**  
Leather covered shelf

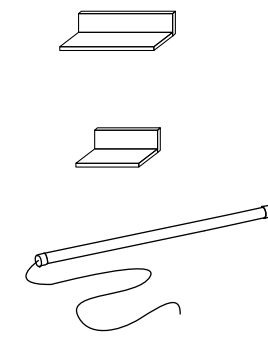

Dimensioni Size	Codice Code	H.L.P.	Tessuti - Fabrics				Pelle - Leather			Tessuto cliente L./H. C.O.M. fabric L./H.	m <sup>2</sup>	kg
			Cat. B	Cat. C/D	Cat. Must	Cat. K	Cat. E	Cat. Plus	Cat. Luxury			
97,5	28M097	0,5x97,5x26								-	0,04	4
65	28M065	0,5x65x26								-	0,02	3
<b>Lampada led</b> Led lamp		31QTLM.M									0,01	0,65

**Lavorazioni su misura solo pannelli lisci e soft**  
Custom made only smooth and soft panels

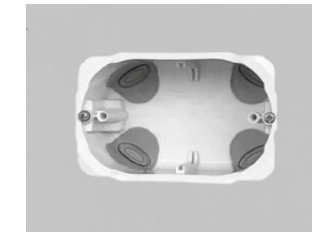

**BOISERIE con scatola elettrica (3 mod.)**  
BOISERIE pred. box (3 mod.)

**Solo boiserie lisce**  
Only smooth boiserie

**Caratteristiche tecniche pannellatura**  
Technical features

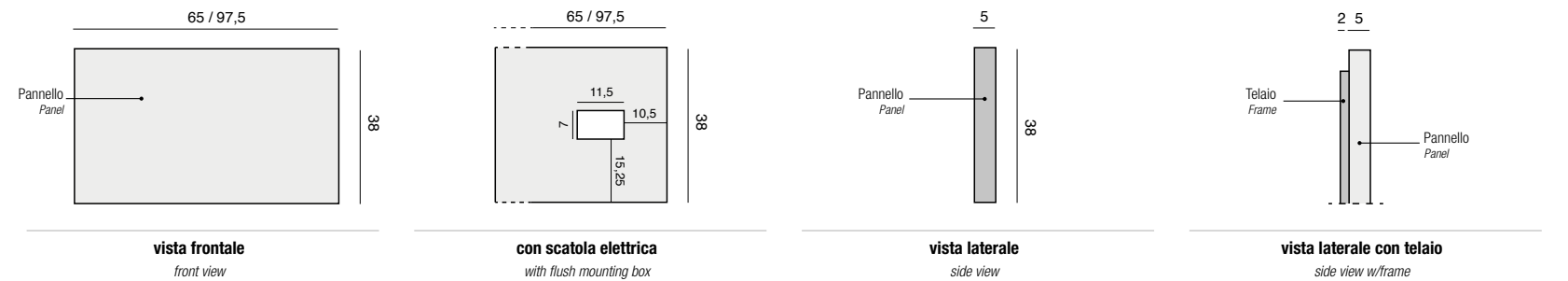

N.B. Le boiserie con scatola elettrica sono realizzabili solo con finitura liscia.  
N.B. Wall panels with flush mounting box, are available only with smooth finishing

**Schema di montaggio**  
Assembly instructions

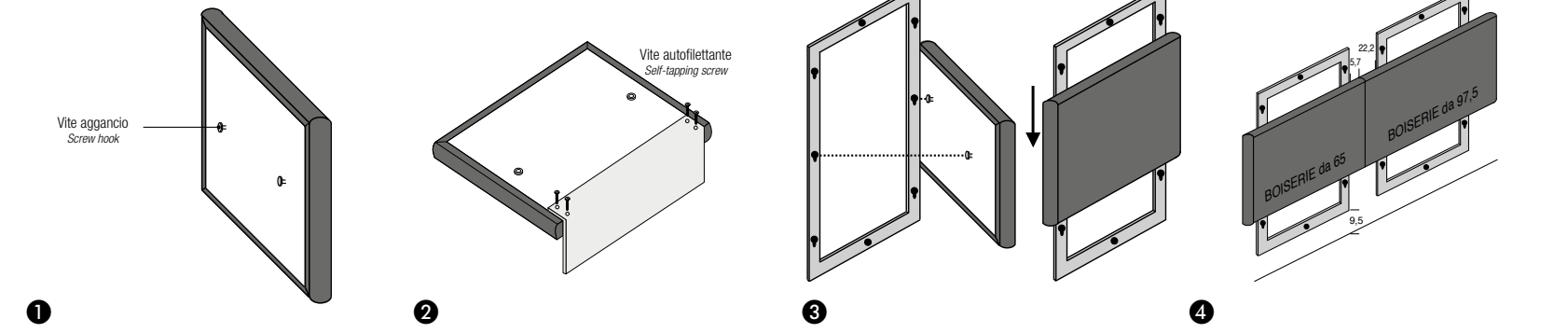

**Ferramenta in dotazione**  
Standard equipment



# Boiserie Set Slim



- Pannello in multistrato di legno di faggio.
- Sempre sfoderabile
- Composizione asimmetrica possibile
- Solid beech plywood
- Removable cover
- Asymmetric solution possible

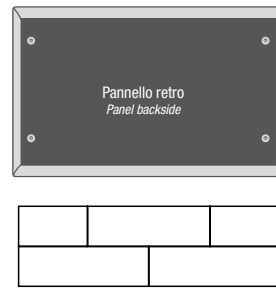

## Boiserie Set Slim spessore 5 H. 17 cm

Boiserie Set Slim thickness 5 H. 17 cm

Dimensioni Size	Codice Code	H.L.P.	Tessuti - Fabrics				Pelle - Leather			Tessuto cliente L./H. C.O.M. fabric L./H.	m³	kg
			Cat. B	Cat. C/D	Cat. Must	Cat. K	Cat. E	Cat. Plus	Cat. Luxury			
60	27I060017	17,5x60x5								0,68x3/1,40	0,03	3
85	27I085017	17,5x85x5								0,96x3/1,40	0,07	4
100	27I100017	17,5x100x5								1,12x3/1,40	0,07	4
120	27I120017	17,5x120x5								1,35x3/1,40	0,07	5
135	27I135017	17,5x135x5								1,50x3/1,40	0,09	6
180	27I180017	17,5x180x5								2,0x3/1,40	0,09	8
200	27I200017	17,5x200x5								2,20x3/1,40	0,09	8

Per rivestimento supplementare vedi pag. 186  
For additional cover see page. 186

## Boiserie Set Slim spessore 5 H. 35 cm

Boiserie Set Slim spessore 5 H. 35 cm

Dimensioni Size	Codice Code	H.L.P.	Tessuti - Fabrics				Pelle - Leather			Tessuto cliente L./H. C.O.M. fabric L./H.	m³	kg
			Cat. B	Cat. C/D	Cat. Must	Cat. K	Cat. E	Cat. Plus	Cat. Luxury			
60	27I060035	35x60x5								0,68x2/1,40	0,03	4
85	27I085035	35x85x5								0,96x2/1,40	0,07	7
100	27I100035	35x100x5								1,12x2/1,40	0,07	7
120	27I120035	35x120x5								1,35x2/1,40	0,07	8
135	27I135035	35x135x5								1,50x2/1,40	0,09	10
180	27I180035	35x180x5								2,0x2/1,40	0,09	12
200	27I200035	35x200x5								2,20x2/1,40	0,09	13

Per rivestimento supplementare vedi pag. 186  
For additional cover see page. 186

# Boiserie Set Slim

## Accessori Set

Set accessories

Dimensioni Size	Codice Code	H.L.P.	Finitura - Finish		m³	kg	Dimensioni Size	Codice Code	H.L.P.	Finitura - Finish		m³	kg
			Grigio antracite (...04)							Grigio antracite (...04)			
56	27N060035	35x56			0,05	6		31QTLM	45x8			0,01	1
116	27N120035	35x116			0,10	12							
176	27N180035	35x176			0,15	19							
0 40	27N040040				0,07	4							
							Solo Nabuk Only Nabuk	31QTSC	31x35			0,01	1

## Esempi

Example

Dimensioni Size	Codice Code	H.L.P.	Tessuti - Fabrics				Pelle - Leather			Tessuto cliente L./H. C.O.M. fabric L./H.	m³	kg
			Cat. B	Cat. C/D	Cat. Must	Cat. K	Cat. E	Cat. Plus	Cat. Luxury			
104x320		104x320x5										
86x320		86x320x5										
135x312		135x312x5										

## Schema di montaggio orizzontale / verticale

Horizontal and vertical assembly instructions

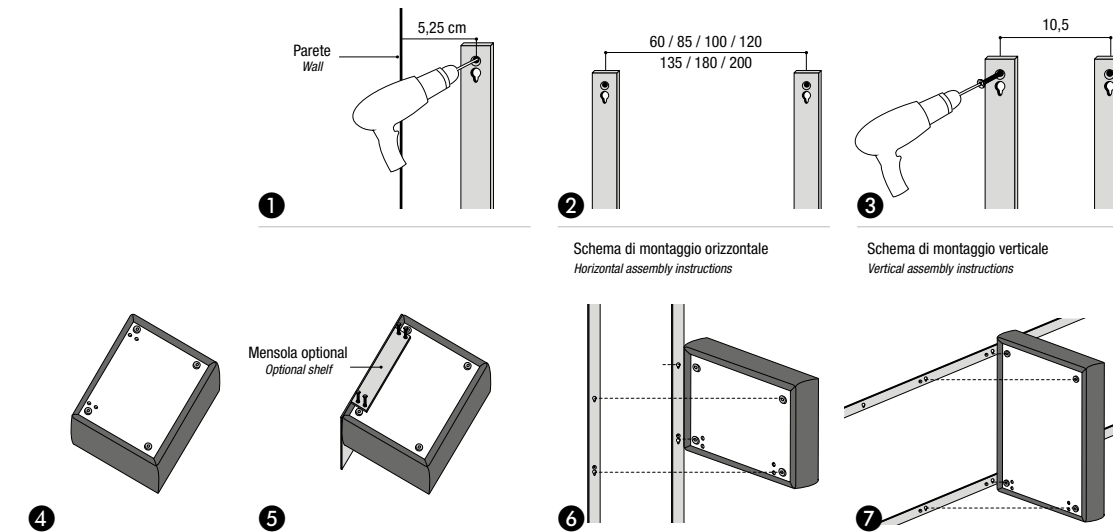

**BOISERIE con scatola elettrica (3 mod.)**  
BOISERIE pred. box (3 mod.)

**Solo boiserie Set Slim spessore 5 H35**  
Only Boiserie Set Slim thickness 5 H35



## Boiserie Oscar



### Schema di montaggio Assembly instructions

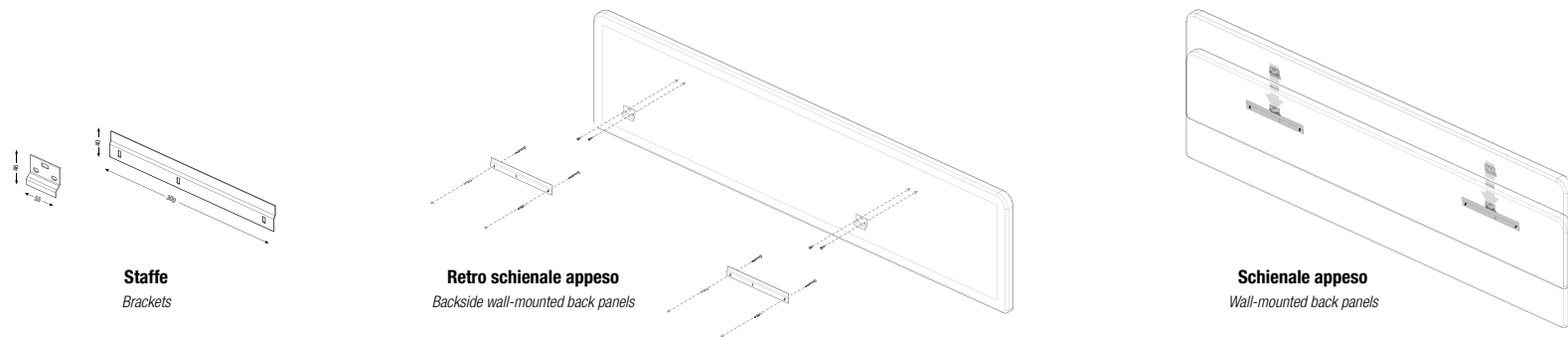

### OSCAR

**Non sfoderabile**  
Not removable cover



Dimensioni materasso Mattress size	Codice Code	H.L.P.	Tessuti - Fabrics				Pelle - Leather			Tessuto cliente L./H. C.O.M. fabric L./H.	m <sup>3</sup>	kg
			Cat. B	Cat. C/D	Cat. Must	Cat. K	Cat. E	Cat. Plus	Cat. Luxury			
180x200	27Z325	110x325x8								7,60/1,40	0,37	54
160x200	27Z275	110x275x8								6,30/1,40	0,31	53

 Per lavorazioni su misura contattare l'azienda  
For custom made contact the company

## Boiserie Oscar Barrè



### Schema di montaggio Assembly instructions

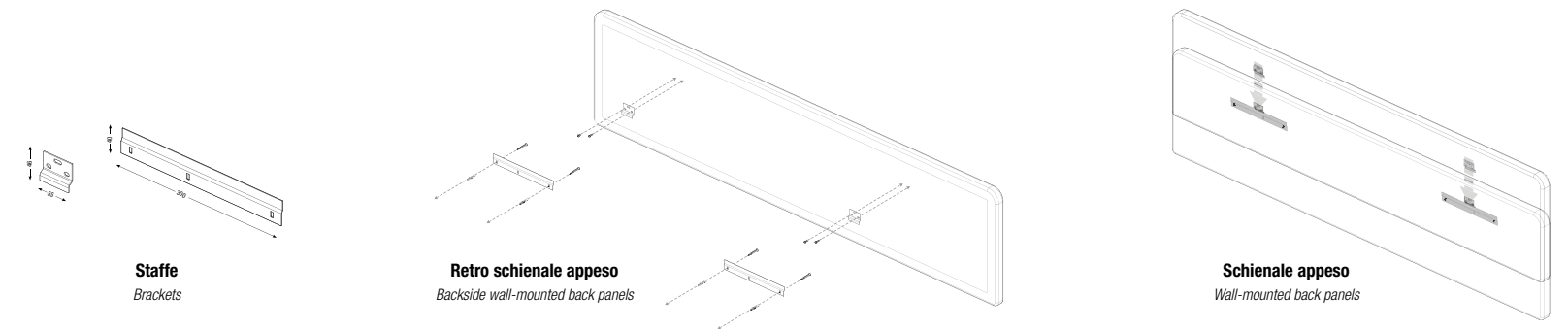

### OSCAR BARRÈ

**Sfoderabile**  
Removable cover



Dimensioni materasso Mattress size	Codice Code	H.L.P.	Tessuti - Fabrics				Pelle - Leather			Tessuto cliente L./H. C.O.M. fabric L./H.	m <sup>3</sup>	kg
			Cat. B	Cat. C/D	Cat. Must	Cat. K	Cat. E	Cat. Plus	Cat. Luxury			
180x200	27Y325	110x325x8								7,60/1,40	0,37	54
160x200	27Y275	110x275x8								6,30/1,40	0,31	53

 Per lavorazioni su misura contattare l'azienda  
For custom made contact the company

 Per rivestimento supplementare vedi pag. 186  
For additional cover see page. 186

## Testiere a parete Wall mounted headboard

### DREAD

**Sfoderabile**  
Removable cover



Dimensioni materasso Mattress size	Codice Code	H.L.P.	Tessuti - Fabrics				Pelle - Leather			Tessuto cliente L./H. C.O.M. fabric L./H.	m <sup>3</sup>	kg
			Cat. B	Cat. C/D	Cat. Must	Cat. K	Cat. E	Cat. Plus	Cat. Luxury			
<b>180x200</b>	144180TAN	100x <b>197</b> x10								4,50/1,40	0,27	38
<b>160x200</b>	144160TAN	100x <b>179</b> x10								4,10/1,40	0,27	35
<b>140x200</b>	144140TAN	100x <b>157</b> x10								3,60/1,40	0,27	30
<b>120x200</b>	144120TAN	100x <b>139</b> x10								3,40/1,40	0,19	25
<b>90x200</b>	144090TAN	100x <b>109</b> x10								2,90/1,40	0,19	20

Per lavorazioni su misura contattare l'azienda  
For custom made contact the company

Per rivestimento supplementare vedi pag. 187  
For additional cover see page. 187

### MAX

**Sfoderabile**  
Removable cover



Dimensioni materasso Mattress size	Codice Code	H.L.P.	Tessuti - Fabrics				Pelle - Leather			Tessuto cliente L./H. C.O.M. fabric L./H.	m <sup>3</sup>	kg
			Cat. B	Cat. C/D	Cat. Must	Cat. K	Cat. E	Cat. Plus	Cat. Luxury			
<b>200x200</b>	186200TAN	90x <b>213</b> x8								4,60/1,40	0,28	20
<b>180x200</b>	186180TAN	90x <b>193</b> x8								4,20/1,40	0,28	20
<b>160x200</b>	186160TAN	90x <b>175</b> x8								3,90/1,40	0,27	20
<b>140x200</b>	186140TAN	90x <b>153</b> x8								3,10/1,40	0,27	17
<b>120x200</b>	186120TAN	90x <b>135</b> x8								2,60/1,40	0,27	17
<b>90x200</b>	186090TAN	90x <b>105</b> x8								2,50/1,40	0,14	12

Per lavorazioni su misura contattare l'azienda  
For custom made contact the company

Per rivestimento supplementare vedi pag. 187  
For additional cover see page. 187

### MAX ALTO

**Sfoderabile**  
Removable cover



Dimensioni materasso Mattress size	Codice Code	H.L.P.	Tessuti - Fabrics				Pelle - Leather			Tessuto cliente L./H. C.O.M. fabric L./H.	m <sup>3</sup>	kg
			Cat. B	Cat. C/D	Cat. Must	Cat. K	Cat. E	Cat. Plus	Cat. Luxury			
<b>200x200</b>	18P200TAN	114x <b>213</b> x8								5,60/1,40	0,27	21
<b>180x200</b>	18P180TAN	114x <b>193</b> x8								5,20/1,40	0,27	21
<b>160x200</b>	18P160TAN	114x <b>175</b> x8								4,70/1,40	0,27	21
<b>140x200</b>	18P140TAN	114x <b>153</b> x8								4,20/1,40	0,27	21
<b>120x200</b>	18P120TAN	114x <b>135</b> x8								2,80/1,40	0,27	21
<b>90x200</b>	18P090TAN	105x <b>121</b> x8								2,80/1,40	0,27	21

Per lavorazioni su misura contattare l'azienda  
For custom made contact the company

Per rivestimento supplementare vedi pag. 187  
For additional cover see page. 187

## Testiere a parete Wall mounted headboard

### MAX ALTO CAPITONNÉ

**Non sfoderabile**  
Not removable cover



Dimensioni materasso Mattress size	Codice Code	H.L.P.	Tessuti - Fabrics				Pelle - Leather			Tessuto cliente L./H. C.O.M. fabric L./H.	m <sup>3</sup>	kg
			Cat. B	Cat. C/D	Cat. Must	Cat. K	Cat. E	Cat. Plus	Cat. Luxury			
<b>200x200</b>	18C200TAN	141x <b>215</b> x7								5,80/1,40	0,22	52
<b>180x200</b>	18C180TAN	145x <b>195</b> x7								5,40/1,40	0,22	52
<b>160x200</b>	18C160TAN	136x <b>177</b> x7								4,90/1,40	0,34	43
<b>140x200</b>	18C140TAN	116x <b>155</b> x7								4,40/1,40	0,34	43
<b>120x200</b>	18C120TAN	116x <b>137</b> x7								3,00/1,40	0,34	43

Per lavorazioni su misura contattare l'azienda  
For custom made contact the company

### MAX BASSO CAPITONNÉ

**Non sfoderabile**  
Not removable cover



Dimensioni materasso Mattress size	Codice Code	H.L.P.	Tessuti - Fabrics				Pelle - Leather			Tessuto cliente L./H. C.O.M. fabric L./H.	m <sup>3</sup>	kg
			Cat. B	Cat. C/D	Cat. Must	Cat. K	Cat. E	Cat. Plus	Cat. Luxury			
<b>200x200</b>	18D200TAN	111x <b>215</b> x7								4,50/1,40	0,29	39
<b>180x200</b>	18D180TAN	113x <b>195</b> x7								4,30/1,40	0,29	39
<b>160x200</b>	18D160TAN	107x <b>177</b> x7								3,70/1,40	0,29	34
<b>140x200</b>	18D140TAN	94x <b>155</b> x7								3,20/1,40	0,29	34
<b>120x200</b>	18D120TAN	94x <b>137</b> x7								3,00/1,40	0,29	27
<b>90x200</b>	18D090TAN	90x <b>137</b> x7								3,40/1,40	0,29	27

Per lavorazioni su misura contattare l'azienda  
For custom made contact the company

### MEDEA

**Sfoderabile**  
Removable cover



Dimensioni materasso Mattress size	Codice Code	H.L.P.	Tessuti - Fabrics				Pelle - Leather			Tessuto cliente L./H. C.O.M. fabric L./H.	m <sup>3</sup>	kg
			Cat. B	Cat. C/D	Cat. Must	Cat. K	Cat. E	Cat. Plus	Cat. Luxury			
<b>180x200</b>	192180TAN	114x <b>201</b> x8								4,30/1,40	0,27	25
<b>160x200</b>	192160TAN	114x <b>183</b> x8								4,00/1,40	0,27	25
<b>140x200</b>	192140TAN	114x <b>161</b> x8								3,60/1,40	0,27	25
<b>120x200</b>	192120TAN	114x <b>143</b> x8								3,20/1,40	0,19	20
<b>90x200</b>	192090TAN	114x <b>113</b> x8								2,50/1,40	0,14	15

Per lavorazioni su misura contattare l'azienda  
For custom made contact the company

Per rivestimento supplementare vedi pag. 187  
For additional cover see page. 187

## Testiere a parete Wall mounted headboard

### OSCAR

**Non sfoderabile**  
Not removable cover



Dimensioni materasso Mattress size	Codice Code	H.L.P.	Tessuti - Fabrics				Pelle - Leather			Tessuto cliente L./H. C.O.M. fabric L./H.	m <sup>3</sup>	kg
			Cat. B	Cat. C/D	Cat. Must	Cat. K	Cat. E	Cat. Plus	Cat. Luxury			
<b>180x200</b>	27Z325	110x325x8								7,60/1,40	0,37	54
<b>160x200</b>	27Z275	110x275x8								6,30/1,40	0,31	53

Per lavorazioni su misura contattare l'azienda  
For custom made contact the company

### OSCAR BARRÈ

**Sfoderabile**  
Removable cover



Dimensioni materasso Mattress size	Codice Code	H.L.P.	Tessuti - Fabrics				Pelle - Leather			Tessuto cliente L./H. C.O.M. fabric L./H.	m <sup>3</sup>	kg
			Cat. B	Cat. C/D	Cat. Must	Cat. K	Cat. E	Cat. Plus	Cat. Luxury			
<b>180x200</b>	27Y325	110x325x8								7,60/1,40	0,37	54
<b>160x200</b>	27Y275	110x375x8								6,30/1,40	0,31	53

Per lavorazioni su misura contattare l'azienda  
For custom made contact the company

Per rivestimento supplementare vedi pag. 186  
For additional cover see page. 186

### TOMMY CAPITONNÈ

**Non sfoderabile**  
Not removable cover



Dimensioni materasso Mattress size	Codice Code	H.L.P.	Tessuti - Fabrics				Pelle - Leather			Tessuto cliente L./H. C.O.M. fabric L./H.	m <sup>3</sup>	kg
			Cat. B	Cat. C/D	Cat. Must	Cat. K	Cat. E	Cat. Plus	Cat. Luxury			
<b>200x200</b>	230200TAN	115x235x12								6,50/1,40	0,68	51
<b>180x200</b>	230180TAN	115x215x12								5,90/1,40	0,68	51
<b>160x200</b>	230160TAN	115x197x12								5,50/1,40	0,61	48

Per lavorazioni su misura contattare l'azienda  
For custom made contact the company

## Testiere a parete Wall mounted headboard

### Schema di montaggio

Assembly instructions

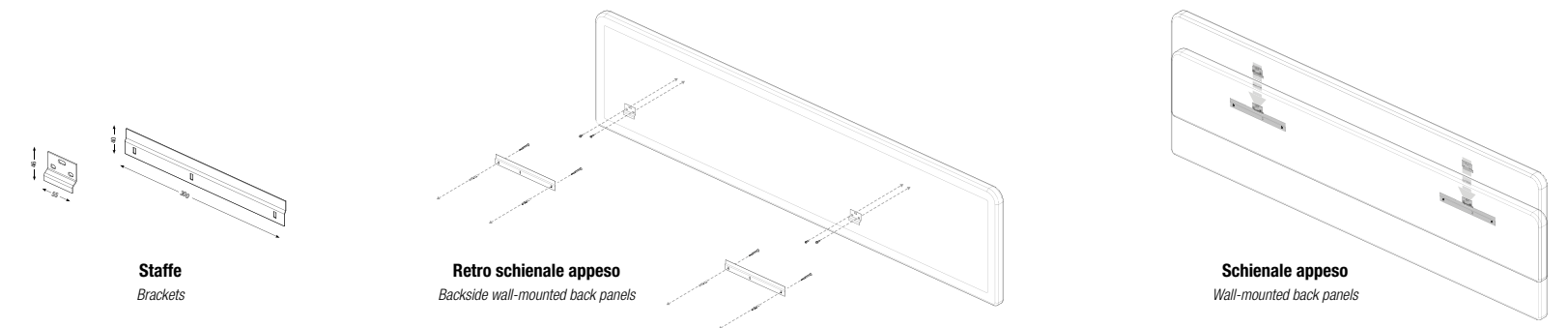

# Ada Sommier

## Letto imbottito con giroletto H. 14 / 28

Upholstered bed with bed frame H. 14 / 28

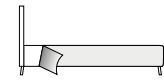

**Sfoderabile**  
Removable cover

**Se abbinato a boiserie o testiera appese di serie 3 lati**

Matching with wall panels / headboards it is always 3-side



## Giroletto H. 14 A- (senza rete)

Bed frame H. 14 A- (without bed base)

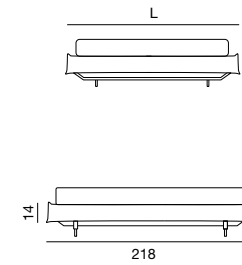

Dimensioni rete/materasso Bed base/ mattress size	Codice letto Bed code	H.L.P.	Tessuti - Fabrics				Pelle - Leather			Tessuto cliente L./H. C.O.M. fabric L./H.	m <sup>3</sup>	kg
			Cat. B	Cat. C/D	Cat. Must	Cat. K	Cat. E	Cat. Plus	Cat. Luxury			
<b>193x203</b>	22319KW3A	33x <b>200</b> x221								4,65/1,40	0,40	44
<b>180x200</b>	223185W3A	33x <b>197</b> x218								4,65/1,40	0,40	44
<b>160x200</b>	223165W3A	33x <b>179</b> x218								4,45/1,40	0,40	43
<b>153x203</b>	22315QW3A	33x <b>172</b> x221								4,45/1,40	0,40	43

Letto per rete o materasso profondo 190 cm nessuna maggiorazione.  
Bed for bed base or mattress with length 190 cm, no extra charge.

### Prezzi per differenza rispetto al piede di serie

Prices difference from the standard feet

### Nella versione in pelle testiera e giroletto hanno una o più cuciture in base alla dimensione della conca

In the leather version, the headboard and bed frame have one or more seams based on the size of the tanned leather

▲ Coppia ruote a richiesta  
Pair of wheels on request

	W	M	T	F	K	V	L	X	Z	H	B
<b>PIE2P</b>											
<b>H. 5</b>											
<b>PIE26</b>											
<b>17x17 H. 5</b>											
<b>PIE3D</b>											
<b>H. 10</b>											

Per rivestimento supplementare vedi pag. 188  
For additional cover see page 188

Per reti ad appoggio vedi pag. 252  
For bed bases see page 252

Per la scelta del materasso vedi pag. 235  
For the choice of mattress see page 235

## Giroletto H. 14 A-Box con box contenitore (rete Ortopedic Plus)

Bed frame H. 14 A-Box with storage  
(Ortopedic Plus bed base)

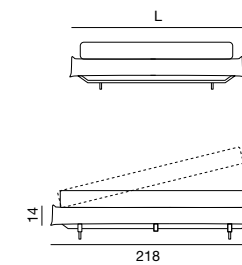

Dimensioni rete/materasso Bed base/ mattress size	Codice letto Bed code	H.L.P.	Tessuti - Fabrics				Pelle - Leather			Tessuto cliente L./H. C.O.M. fabric L./H.	m <sup>3</sup>	kg
			Cat. B	Cat. C/D	Cat. Must	Cat. K	Cat. E	Cat. Plus	Cat. Luxury			
<b>193x203</b>	22319KW3A KBTAB019K	33x <b>200</b> x221								4,65/1,40	0,83	131
<b>180x200</b>	223185W3A KBTAB0185	33x <b>197</b> x218								4,65/1,40	0,69	118
<b>160x200</b>	223165W3A KBTAB0165	33x <b>179</b> x218								4,45/1,40	0,67	112
<b>153x203</b>	22315QW3A KBTAB015Q	33x <b>172</b> x221								4,45/1,40	0,67	112

Letto per rete o materasso profondo 190 cm nessuna maggiorazione.  
Bed for bed base or mattress with length 190 cm, no extra charge.

Sommier 3 lati maggiorazione  
Extra charge for Sommier 3-sides

LAVORAZIONI SU MISURA CUSTOM MADE	Modifica altezza passo 5 cm Change in Height 5 cm pitch			Modifica lunghezza passo 5 cm Change in Length 5 cm pitch			Modifica larghezza passo 5 cm Change in Width 5 cm pitch		
	<b>Rete 195 o 205 Rete strutturale</b> Bed base 195 or 205 Structural bed base	<b>Rete 195 o 205 Box contenitore NO A-BOX</b> Bed base 195 or 205 Storage box NO A-BOX	<b>Rete 195 o 205 Letto senza rete</b> Bed base 195 or 205 Bed without bed base	<b>Rete a filo longone Rete strutturale</b> Bed base flushed with bed frame Bed without bed base	<b>Rete a filo longone Box contenitore</b> Bed base flushed with bed frame Storage box	<b>Rete a filo longone Letto senza rete</b> Bed base flushed with bed frame Bed without bed base			

Per le tempistiche di consegna su lavorazioni a misura contattare l'Azienda / To learn about delivery times for customizations, please contact the company

Box contenitore: scheda tecnica e accessori vedi pag. 23-26  
Technical Sheet storage box and accessories see page 23-26

Per rivestimento supplementare vedi pag. 188  
For additional cover see page 188

Per box contenitore con rete non di serie vedi pag. 25  
For storage box with no standard bed base see page 25

Per la scelta del materasso vedi pag. 235  
For the choice of mattress see page 235



## Giroletto H. 28 senza rete

Bed frame H. 28 without bed base

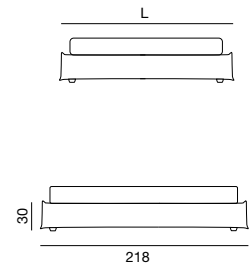

Dimensioni rete/materasso Bed base/ mattress size	Codice letto Bed code	H.L.P.	Tessuti - Fabrics				Pelle - Leather			Tessuto cliente L./H. C.O.M. fabric L./H.	m <sup>3</sup>	kg
			Cat. B	Cat. C/D	Cat. Must	Cat. K	Cat. E	Cat. Plus	Cat. Luxury			
<b>200x200</b>	223205W8N	33x <b>207</b> x218								4,65/1,40	0,40	44
<b>193x203</b>	22319KW8N	33x <b>200</b> x221								4,65/1,40	0,40	44
<b>180x200</b>	223185W8N	33x <b>197</b> x218								4,65/1,40	0,40	44
<b>160x200</b>	223165W8N	33x <b>179</b> x218								4,45/1,40	0,40	43
<b>153x203</b>	22315QW8N	33x <b>172</b> x221								4,45/1,40	0,40	43
<b>120x200</b>	223125W8N	33x <b>139</b> x218								4,10/1,40	0,32	41

Letto per rete o materasso profondo 190 cm nessuna maggiorazione. Con profondità 210 cm maggiorazione (escluso misure 153x203 e 193x203)  
Bed for bed base or mattress with length 190 cm, no extra charge. With length 210 cm, extra charge (excluded dimensions 153x203 and 193x203)

Sommier 3 lati maggiorazione  
Extra charge for Sommier 3-sides



Cod. **PIE2P Madreperla H. 5**



Per rivestimento supplementare vedi pag. 188  
For additional cover see page. 188



Per reti ad appoggio vedi pag. 252  
For bed bases see page 252



Per la scelta del materasso vedi pag. 235  
For the choice of mattress see page 235

## Giroletto H. 28 con box contenitore (rete Ortopedic Plus)

Bed frame H. 28 with storage (Ortopedic Plus bed base)

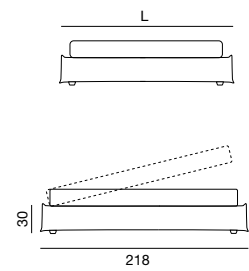

Dimensioni rete/materasso Bed base/ mattress size	Codice letto Bed code	H.L.P.	Tessuti - Fabrics				Pelle - Leather			Tessuto cliente L./H. C.O.M. fabric L./H.	m <sup>3</sup>	kg
			Cat. B	Cat. C/D	Cat. Must	Cat. K	Cat. E	Cat. Plus	Cat. Luxury			
<b>200x200</b>	223205W8N KBT80C205	33x <b>207</b> x218								4,65/1,40	0,83	131
<b>193x203</b>	22319KW8N KBT80C19K	33x <b>200</b> x221								4,65/1,40	0,83	131
<b>180x200</b>	223185W8N KBT80C185	33x <b>197</b> x218								4,65/1,40	0,69	118
<b>160x200</b>	223165W8N KBT80C165	33x <b>179</b> x218								4,45/1,40	0,67	112
<b>153x203</b>	22315QW8N KBT80C15Q	33x <b>172</b> x221								4,45/1,40	0,67	112
<b>120x200</b>	223125W8N KBT80C125	33x <b>139</b> x218								4,10/1,40	0,54	99

Letto per rete o materasso profondo 190 cm nessuna maggiorazione. Con profondità 210 cm maggiorazione (escluso misure 153x203 e 193x203)  
Bed for bed base or mattress with length 190 cm, no extra charge. With length 210 cm, extra charge (excluded dimensions 153x203 and 193x203)

Sommier 3 lati maggiorazione  
Extra charge for Sommier 3-sides



Cod. **PIE2P Madreperla H. 5**

Box contenitore: scheda tecnica e accessori vedi pag. 23-26  
Technical Sheet storage box and accessories see page 23-26



Per rivestimento supplementare vedi pag. 188  
For additional cover see page. 188



Per box contenitore con rete non di serie vedi patella fine listino letti  
For storage box with no standard bed base see at the end of bed price list  
(inside folding cover)



Per la scelta del materasso vedi pag. 235  
For the choice of mattress see page 235





# Ekeko Sommier

## Letto imbottito con giroletto H. 28

Upholstered bed with bed frame H. 28

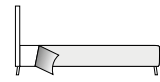

**Sfoderabile**  
Removable cover



## Giroletto H. 28 con box contenitore (rete Ortopedic Plus)

Bed frame H. 28 with storage (Ortopedic Plus bed base)

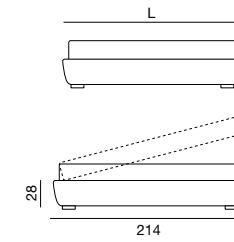

Dimensioni rete/materasso Bed base/ mattress size	Codice letto Bed code	H.L.P.	Tessuti - Fabrics				Pelle - Leather			Tessuto cliente L./H. C.O.M. fabric L./H.	m <sup>3</sup>	kg
			Cat. B	Cat. C/D	Cat. Must	Cat. K	Cat. E	Cat. Plus	Cat. Luxury			
<b>180x200</b>	22318509N KBE80C185	30x <b>193</b> x214								5,80/1,40	0,82	83
<b>160x200</b>	22316509N KBE80C165	30x <b>175</b> x214								5,40/1,40	0,8	78

### Prezzi per differenza rispetto al piede di serie

Prices difference from the standard feet

Nella versione in pelle testiera e giroletto hanno una o più cuciture in base alla dimensione della concia  
In the leather version, the headboard and bed frame have one or more seams based on the size of the tanned leather

	W	M	T	F	K	V	L	X	Z	H	B
<b>H. 28</b>											
<b>PIE1EVK</b>											
<b>H. 4</b>											



Cod. **PIE1EVK Termocotto**  
**H. 4**

Box contenitore: scheda tecnica e accessori vedi pag. 23-26  
Technical Sheet storage box and accessories see page 23-26



Per rivestimento supplementare vedi pag. 188  
For additional cover see page. 188



Per box contenitore con rete non di serie vedi patella fine listino letti  
For storage box with no standard bed base see at the end of bed price list (inside folding cover)



Per la scelta del materasso vedi pag. 235  
For the choice of mattress see page 235

<b>LAVORAZIONI SU MISURA</b> CUSTOM MADE	Modifica altezza passo 5 cm Change in Height 5 cm pitch	Modifica lunghezza passo 5 cm Change in Length 5 cm pitch	Modifica larghezza passo 5 cm Change in Width 5 cm pitch	<b>Rete 195 o 205 Rete strutturale</b> Bed base 195 or 205 Structural bed base	<b>Rete 195 o 205 Box contenitore NO A-BOX</b> Bed base 195 or 205 Storage box NO A-BOX	<b>Rete 195 o 205 Letto senza rete</b> Bed base 195 or 205 Bed without bed base	<b>Rete a filo longone Rete strutturale</b> Bed base flushed with bed frame Bed without bed base	<b>Rete a filo longone Box contenitore</b> Bed base flushed with bed frame Storage box	<b>Rete a filo longone Letto senza rete</b> Bed base flushed with bed frame Bed without bed base
	NO	NO	NO	NO	NO	NO	NO	NO	NO

Per le tempistiche di consegna su lavorazioni a misura contattare l'Azienda / To learn about delivery times for customizations, please contact the company

# Max Sommier

## Letto imbottito con giroletto H. 14 / 25

Upholstered bed with bed frame H. 14 / 25

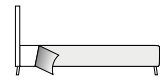

**Sfoderabile (no in pelle)**  
Removable cover (no leather)

**Se abbinato a boiserie o testiera appese di serie 3 lati**  
Matching with wall panels / headboards it is always 3-side



**Prezzi per differenza rispetto al piede di serie**  
Prices difference from the standard feet

**Nella versione in pelle testiera e giroletto hanno una o più cuciture in base alla dimensione della conca**  
In the leather version, the headboard and bed frame have one or more seams based on the size of the tanned leather

	W	M	T	F	K	V	L	X	Z	H	B
<b>▲ Coppia ruote a richiesta</b> Pair of wheels on request											
<b>H. 14</b>											
PIE61											
H. 18											
PIEST											
H. 18											
PIEMAX											
H. 18											
PIE6D											
H. 17											
PIEC6MZ010											
H. 18											
<b>H. 25</b>											
PIE3D											
H. 10											
PIE26											
17x17 H. 5											
PIE41L											
H. 10											
PIE4D											
H. 12											
PIE4SZ											
H. 13											
PIEMAY											
H. 13											

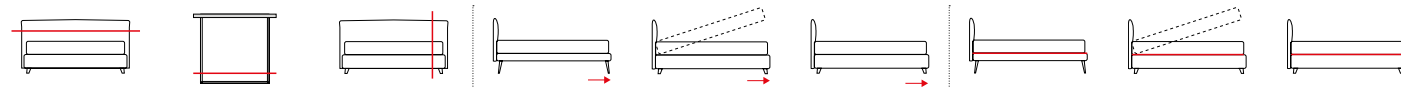

LAVORAZIONI SU MISURA CUSTOM MADE	Modifica altezza passo 5 cm Change in Height 5 cm pitch	Modifica lunghezza passo 5 cm Change in Length 5 cm pitch	Modifica larghezza passo 5 cm Change in Width 5 cm pitch	Rete 195 o 205 Rete strutturale Bed base 195 or 205 Structural bed base	Rete 195 o 205 Box contenitore NO A-BOX Bed base 195 or 205 Storage box NO A-BOX	Rete 195 o 205 Letto senza rete Bed base 195 or 205 Bed without bed base	Rete a filo longone Rete strutturale Bed base flushed with bed frame Bed without bed base	Rete a filo longone Box contenitore Bed base flushed with bed frame Storage box	Rete a filo longone Letto senza rete Bed base flushed with bed frame Bed without bed base

Per le tempistiche di consegna su lavorazioni a misura contattare l'Azienda / To learn about delivery times for customizations, please contact the company

## Giroletto H. 14 con rete strutturale (rete Ortopedic)

Bed frame H. 14 with structural bed base (Ortopedic bed base)

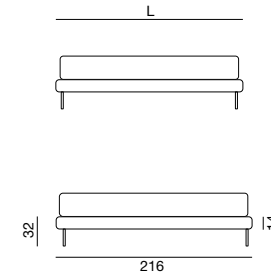

Dimensioni rete/materasso Bed base/ mattress size	Codice letto Bed code	H.L.P.	Tessuti - Fabrics				Pelle - Leather			Tessuto cliente L./H. C.O.M. fabric L./H.	m <sup>3</sup>	kg
			Cat. B	Cat. C/D	Cat. Must	Cat. K	Cat. E	Cat. Plus	Cat. Luxury			
200x200	22320553N	32x213x216								3,70/1,40	0,38	75
193x203	22319K53N	32x206x219								3,70/1,40	0,38	75
180x200	22318553N	32x193x216								3,55/1,40	0,35	69
170x200	22317553N	32x183x216								3,45/1,40	0,33	66
160x200	22316553N	32x175x216								3,45/1,40	0,33	63
153x203	22315Q53N	32x168x219								3,45/1,40	0,33	63
140x200	22314553N	32x153x216								3,30/1,40	0,29	61
120x200	22312553N	32x135x216								2,90/1,40	0,26	56
100x200	22310553N	32x113x216								2,70/1,40	0,23	50
90x200	22309553N	32x105x216								2,50/1,40	0,22	49

Letto per rete o materasso profondo 190 cm nessuna maggiorazione. Con profondità 210 cm maggiorazione (escluso misure 153x203 e 193x203)  
Bed for bed base or mattress with length 190 cm, no extra charge. With length 210 cm, extra charge (excluded dimensions 153x203 and 193x203)

Sommier 3 lati maggiorazione  
Extra charge for Sommier 3-sides



Cod. PIE61 Alluminio lucido  
H. 18



Per rivestimento supplementare vedi pag. 188  
For additional cover see page 188



Per la scelta del materasso vedi pag. 235  
For the choice of mattress see page 235

## Giroletto H. 14 senza rete

Bed frame H. 14 without bed base

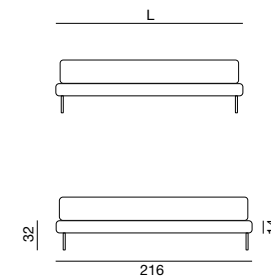

Dimensioni rete/materasso Bed base/ mattress size	Codice letto Bed code	H.L.P.	Tessuti - Fabrics				Pelle - Leather			Tessuto cliente L./H. C.O.M. fabric L./H.	m <sup>3</sup>	kg
			Cat. B	Cat. C/D	Cat. Must	Cat. K	Cat. E	Cat. Plus	Cat. Luxury			
200x200	22320553I	32x213x216								3,70/1,40	0,38	75
193x203	22319K53I	32x206x219								3,70/1,40	0,38	75
180x200	22318553I	32x193x216								3,55/1,40	0,35	69
170x200	22317553I	32x183x216								3,45/1,40	0,33	66
160x200	22316553I	32x177x216								3,45/1,40	0,33	63
153x203	22315Q53I	32x170x219								3,45/1,40	0,33	63
140x200	22314553I	32x153x216								3,30/1,40	0,29	61
120x200	22312553I	32x135x216								2,90/1,40	0,26	56
100x200	22310553I	32x113x216								2,70/1,40	0,23	50
90x200	22309553I	32x105x216								2,50/1,40	0,22	49

Letto per rete o materasso profondo 190 cm nessuna maggiorazione. Con profondità 210 cm maggiorazione (escluso misure 153x203 e 193x203)  
Bed for bed base or mattress with length 190 cm, no extra charge. With length 210 cm, extra charge (excluded dimensions 153x203 and 193x203)



Cod. PIE61 Alluminio lucido  
H. 18



Per rivestimento supplementare vedi pag. 188  
For additional cover see page 188



Per reti ad appoggio vedi pag. 252  
For bed bases see page 252



Per la scelta del materasso vedi pag. 235  
For the choice of mattress see page 235

**Giroletto H. 14 A- (senza rete)**

Bed frame H. 14 A- (without bed base)

Dimensioni rete/materasso Bed base/ mattress size	Codice letto Bed code	H.L.P.	Tessuti - Fabrics				Pelle - Leather			Tessuto cliente L./H. C.O.M. fabric L./H.	m <sup>3</sup>	kg
			Cat. B	Cat. C/D	Cat. Must	Cat. K	Cat. E	Cat. Plus	Cat. Luxury			
<b>193x203</b>	22319K53A	32x <b>206</b> x219								3,70/1,40	0,38	75
<b>180x200</b>	22318553A	32x <b>193</b> x216								3,55/1,40	0,35	69
<b>160x200</b>	22316553A	32x <b>177</b> x216								3,45/1,40	0,33	63
<b>153x203</b>	22315Q53A	32x <b>170</b> x219								3,45/1,40	0,33	63

Letto per rete o materasso profondo 190 cm nessuna maggiorazione.  
Bed for bed base or mattress with length 190 cm, no extra charge.

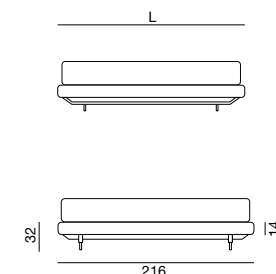

**Giroletto H. 25 senza rete**

Bed frame H. 25 without bed base

Dimensioni rete/materasso Bed base/ mattress size	Codice letto Bed code	H.L.P.	Tessuti - Fabrics				Pelle - Leather			Tessuto cliente L./H. C.O.M. fabric L./H.	m <sup>3</sup>	kg
			Cat. B	Cat. C/D	Cat. Must	Cat. K	Cat. E	Cat. Plus	Cat. Luxury			
<b>200x200</b>	22320558N	38x <b>213</b> x214								3,70/1,40	0,25	32
<b>193x203</b>	22319K58N	38x <b>206</b> x217								3,70/1,40	0,25	32
<b>180x200</b>	22318558N	38x <b>193</b> x214								3,55/1,40	0,25	31
<b>170x200</b>	22317558N	38x <b>183</b> x214								3,45/1,40	0,24	31
<b>160x200</b>	22316558N	38x <b>175</b> x214								3,45/1,40	0,24	30
<b>153x203</b>	22315Q58N	38x <b>168</b> x217								3,45/1,40	0,24	30
<b>140x200</b>	22314558N	38x <b>153</b> x214								3,30/1,40	0,24	28
<b>120x200</b>	22312558N	38x <b>135</b> x214								2,90/1,40	0,21	26
<b>100x200</b>	22310558N	38x <b>113</b> x214								2,70/1,40	0,20	25
<b>90x200</b>	22309558N	38x <b>105</b> x214								2,50/1,40	0,19	25

Letto per rete o materasso profondo 190 cm nessuna maggiorazione. Con profondità 210 cm maggiorazione (escluso misure 153x203 e 193x203)  
Bed for bed base or mattress with length 190 cm, no extra charge. With length 210 cm, extra charge (excluded dimensions 153x203 and 193x203)

Sommier 3 lati maggiorazione  
Extra charge for Sommier 3-sides

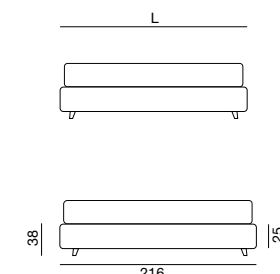

Per rivestimento supplementare vedi pag. 188  
For additional cover see page. 188

Per reti ad appoggio vedi pag. 252  
For bed bases see page 252

Per la scelta del materasso vedi pag. 235  
For the choice of mattress see page 235

**Giroletto H. 14 A-Box con box contenitore (rete Ortopedic Plus)**

Bed frame H. 14 A-Box with storage  
(Ortopedic Plus bed base)

Dimensioni rete/materasso Bed base/ mattress size	Codice letto Bed code	H.L.P.	Tessuti - Fabrics				Pelle - Leather			Tessuto cliente L./H. C.O.M. fabric L./H.	m <sup>3</sup>	kg
			Cat. B	Cat. C/D	Cat. Must	Cat. K	Cat. E	Cat. Plus	Cat. Luxury			
<b>193x203</b>	22319K53A KBTAB019K	32x <b>209</b> x219								3,70/1,40	0,65	115
<b>180x200</b>	22318553A KBTAB0185	32x <b>193</b> x216								3,55/1,40	0,51	101
<b>160x200</b>	22316553A KBTAB0165	32x <b>175</b> x216								3,45/1,40	0,49	96
<b>153x203</b>	22315Q53A KBTAB015Q	32x <b>169</b> x219								3,45/1,40	0,49	96

Letto per rete o materasso profondo 190 cm nessuna maggiorazione.  
Bed for bed base or mattress with length 190 cm, no extra charge.

Sommier 3 lati maggiorazione  
Extra charge for Sommier 3-sides

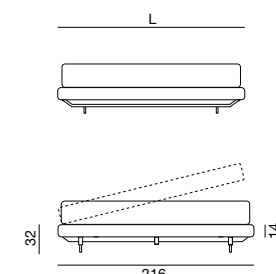

Cod. **PIE3D Madreperla H. 10**

Per rivestimento supplementare vedi pag. 188  
For additional cover see page. 188

Per reti ad appoggio vedi pag. 252  
For bed bases see page 252

Per la scelta del materasso vedi pag. 235  
For the choice of mattress see page 235

**Giroletto H. 25 con box contenitore (rete Ortopedic Plus)**

Bed frame H. 25 with storage (Ortopedic Plus bed base)

Dimensioni rete/materasso Bed base/ mattress size	Codice letto Bed code	H.L.P.	Tessuti - Fabrics				Pelle - Leather			Tessuto cliente L./H. C.O.M. fabric L./H.	m <sup>3</sup>	kg
			Cat. B	Cat. C/D	Cat. Must	Cat. K	Cat. E	Cat. Plus	Cat. Luxury			
<b>200x200</b>	22320558N KBT80C205	38x <b>213</b> x214								3,70/1,40	0,68	119
<b>193x203</b>	22319K58N KBT80C19K	38x <b>206</b> x217								3,70/1,40	0,68	119
<b>180x200</b>	22318558N KBT80C185	38x <b>193</b> x214								3,55/1,40	0,54	105
<b>170x200</b>	22317558N KBT80C175	38x <b>183</b> x214								3,45/1,40	0,52	101
<b>160x200</b>	22316558N KBT80C165	38x <b>175</b> x214								3,45/1,40	0,51	99
<b>153x203</b>	22315Q58N KBT80C15Q	38x <b>168</b> x217								3,45/1,40	0,51	99
<b>140x200</b>	22314558N KBT80C145	38x <b>153</b> x214								3,30/1,40	0,48	88
<b>120x200</b>	22312558N KBT80C125	38x <b>135</b> x214								2,90/1,40	0,43	84
<b>100x200</b>	22310558N KBT80C105	38x <b>113</b> x214								2,70/1,40	0,39	70
<b>90x200</b>	22309558N KBT80C095	38x <b>105</b> x214								2,50/1,40	0,37	68

Letto per rete o materasso profondo 190 cm nessuna maggiorazione. Con profondità 210 cm maggiorazione (escluso misure 153x203 e 193x203)  
Bed for bed base or mattress with length 190 cm, no extra charge. With length 210 cm, extra charge (excluded dimensions 153x203 and 193x203)

Sommier 3 lati maggiorazione  
Extra charge for Sommier 3-sides

Cod. **PIE3D Madreperla H. 10**

Per rivestimento supplementare vedi pag. 188  
For additional cover see page. 188

Per box contenitore con rete non di serie vedi patella fine listino letti  
For storage box with no standard bed base see at the end of bed price list (inside folding cover)

Per la scelta del materasso vedi pag. 235  
For the choice of mattress see page 235

Box contenitore: scheda tecnica e accessori vedi pag. 23-26  
Technical Sheet storage box and accessories see page 23-26

Box contenitore: scheda tecnica e accessori vedi pag. 23-26  
Technical Sheet storage box and accessories see page 23-26



# Sommier

## Letto imbottito con giroletto H. 14 / 25

Upholstered bed with bed frame H. 14 / 25

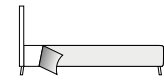

**Sfoderabile**  
Removable cover

**Se abbinato a boiserie o testiera appese di serie 3 lati**

Matching with wall panels / headboards it is always 3-side



**Prezzi per differenza rispetto al piede di serie**  
Prices difference from the standard feet

**Nella versione in pelle testiera e giroletto hanno una o più cuciture in base alla dimensione della conca**  
In the leather version, the headboard and bed frame have one or more seams based on the size of the tanned leather

	W	M	T	F	K	V	L	X	Z	H	B
<b>H. 14</b>											
<b>H. 24</b>											
<b>H. 25</b>											
<b>H. 10</b>											
<b>H. 12</b>											

♦ Utile H. 18 con rete strutturale  
Real height H. 18 with structural bed base

## Giroletto H. 14 con rete strutturale (rete Ortopedic)

Bed frame H. 14 with structural bed base (Ortopedic bed base)

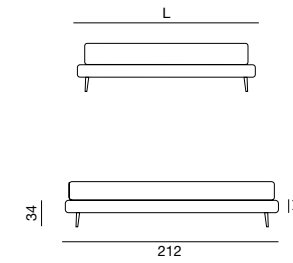

Dimensioni rete/materasso Bed base/ mattress size	Codice letto Bed code	H.L.P.	Tessuti - Fabrics				Pelle - Leather			Tessuto cliente L./H. C.O.M. fabric L./H.	m <sup>3</sup>	kg
			Cat. B	Cat. C/D	Cat. Must	Cat. K	Cat. E	Cat. Plus	Cat. Luxury			
<b>200x200</b>	22320533N	34x <b>212</b> x212								3,60/1,40	0,38	54
<b>193x203</b>	22319K33N	34x <b>205</b> x215								3,60/1,40	0,38	54
<b>180x200</b>	22318533N	34x <b>192</b> x212								3,45/1,40	0,36	49
<b>170x200</b>	22317533N	34x <b>182</b> x212								3,40/1,40	0,34	47
<b>160x200</b>	22316533N	34x <b>174</b> x212								3,40/1,40	0,33	45
<b>153x203</b>	22315Q33N	34x <b>167</b> x215								3,40/1,40	0,33	45
<b>140x200</b>	22314533N	34x <b>152</b> x212								3,25/1,40	0,30	43
<b>120x200</b>	22312533N	34x <b>134</b> x212								3,10/1,10	0,27	38
<b>100x200</b>	22310533N	34x <b>112</b> x212								2,60/1,40	0,24	33
<b>90x200</b>	22309533N	34x <b>104</b> x212								2,45/1,40	0,22	33

Letto per rete o materasso profondo 190 cm nessuna maggiorazione. Con profondità 210 cm maggiorazione (escluso misure 153x203 e 193x203)  
Bed for bed base or mattress with length 190 cm, no extra charge. With length 210 cm, extra charge (excluded dimensions 153x203 and 193x203)

Sommier 3 lati maggiorazione  
Extra charge for Sommier 3-sides



Cod. **PIE88 Madreperla H. 24**



Per rivestimento supplementare vedi pag. 189  
For additional cover see page. 189



Per la scelta del materasso vedi pag. 235  
For the choice of mattress see page 235

## Giroletto H. 25 senza rete

Bed frame H. 25 without bed base

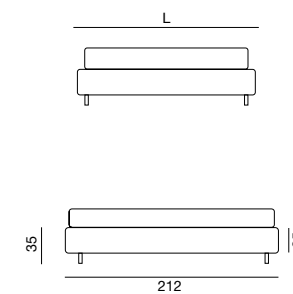

Dimensioni rete/materasso Bed base/ mattress size	Codice letto Bed code	H.L.P.	Tessuti - Fabrics				Pelle - Leather			Tessuto cliente L./H. C.O.M. fabric L./H.	m <sup>3</sup>	kg
			Cat. B	Cat. C/D	Cat. Must	Cat. K	Cat. E	Cat. Plus	Cat. Luxury			
<b>200x200</b>	22320577N	35x <b>212</b> x212								3,60/1,40	0,38	54
<b>193x203</b>	22319K77N	35x <b>205</b> x215								3,60/1,40	0,38	54
<b>180x200</b>	22318577N	35x <b>192</b> x212								3,45/1,40	0,36	49
<b>170x200</b>	22317577N	35x <b>182</b> x212								3,40/1,40	0,34	47
<b>160x200</b>	22316577N	35x <b>174</b> x212								3,40/1,40	0,33	45
<b>153x203</b>	22315Q77N	35x <b>167</b> x215								3,40/1,40	0,33	45
<b>140x200</b>	22314577N	35x <b>152</b> x212								3,25/1,40	0,30	43
<b>120x200</b>	22312577N	35x <b>134</b> x212								3,10/1,10	0,27	38
<b>100x200</b>	22310577N	35x <b>112</b> x212								2,60/1,40	0,24	33
<b>90x200</b>	22309577N	35x <b>104</b> x212								2,45/1,40	0,22	33

Letto per rete o materasso profondo 190 cm nessuna maggiorazione. Con profondità 210 cm maggiorazione (escluso misure 153x203 e 193x203)  
Bed for bed base or mattress with length 190 cm, no extra charge. With length 210 cm, extra charge (excluded dimensions 153x203 and 193x203)

Sommier 3 lati maggiorazione  
Extra charge for Sommier 3-sides



Cod. **PIE38 Madreperla H. 10**



Per rivestimento supplementare vedi pag. 189  
For additional cover see page. 189



Per reti ad appoggio vedi pag. 252  
For bed bases see page 252



Per la scelta del materasso vedi pag. 235  
For the choice of mattress see page 235

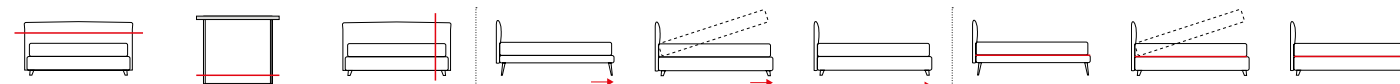

LAVORAZIONI SU MISURA CUSTOM MADE	Modifica altezza passo 5 cm Change in Height 5 cm pitch	Modifica lunghezza passo 5 cm Change in Length 5 cm pitch	Modifica larghezza passo 5 cm Change in Width 5 cm pitch	Rete 195 o 205 <b>Rete strutturale</b> Bed base 195 or 205 Structural bed base	Rete 195 o 205 <b>Box contenitore NO A-BOX</b> Bed base 195 or 205 Storage box NO A-BOX	Rete 195 o 205 <b>Letto senza rete</b> Bed base 195 or 205 Bed without bed base	Rete a filo longone <b>Rete strutturale</b> Bed base flushed with bed frame Bed without bed base	Rete a filo longone <b>Box contenitore</b> Bed base flushed with bed frame Storage box	Rete a filo longone <b>Letto senza rete</b> Bed base flushed with bed frame Bed without bed base

Per le tempistiche di consegna su lavorazioni a misura contattare l'Azienda / To learn about delivery times for customizations, please contact the company



**Giroletto H. 25 con box contenitore (rete Ortopedic Plus)**

Bed frame H. 25 with storage (Ortopedic Plus bed base)

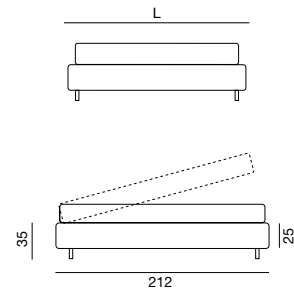

Dimensioni rete/materasso Bed base/ mattress size	Codice letto Bed code	H.L.P.	Tessuti - Fabrics				Pelle - Leather			Tessuto cliente L./H. C.O.M. fabric L./H.	m <sup>3</sup>	kg
			Cat. B	Cat. C/D	Cat. Must	Cat. K	Cat. E	Cat. Plus	Cat. Luxury			
<b>200x200</b>	22320577N KBT80C205	35x <b>212</b> x212								3,60/1,40	0,81	141
<b>193x203</b>	22319K77N KBT80C19K	35x <b>205</b> x215								3,60/1,40	0,81	141
<b>180x200</b>	22318577N KBT80C185	35x <b>192</b> x212								3,45/1,40	0,65	123
<b>170x200</b>	22317577N KBT80C175	35x <b>182</b> x212								3,40/1,40	0,62	117
<b>160x200</b>	22316577N KBT80C165	35x <b>174</b> x212								3,40/1,40	0,6	114
<b>153x203</b>	22315Q77N KBT80C15Q	35x <b>167</b> x215								3,40/1,40	0,6	114
<b>140x200</b>	22314577N KBT80C145	35x <b>152</b> x212								3,25/1,40	0,54	103
<b>120x200</b>	22312577N KBT80C125	35x <b>134</b> x212								3,10/1,10	0,49	96
<b>100x200</b>	22310577N KBT80C105	35x <b>112</b> x212								2,60/1,40	0,43	78
<b>90x200</b>	22309577N KBT80C095	35x <b>104</b> x212								2,45/1,40	0,4	76

Letto per rete o materasso profondo 190 cm nessuna maggiorazione. Con profondità 210 cm maggiorazione (escluso misure 153x203 e 193x203)  
Bed for bed base or mattress with length 190 cm, no extra charge. With length 210 cm, extra charge (excluded dimensions 153x203 and 193x203)

Sommier 3 lati maggiorazione  
Extra charge for Sommier 3-sides



Cod. **PIE38 Madreperla H. 10**

Box contenitore: scheda tecnica e accessori vedi pag. 23-26  
Technical Sheet storage box and accessories see page 23-26



Per rivestimento supplementare vedi pag. 189  
For additional cover see page. 189



Per box contenitore con rete non di serie vedi patella fine listino letti  
For storage box with no standard bed base see at the end of bed price list (inside folding cover)



Per la scelta del materasso vedi pag. 235  
For the choice of mattress see page 235





# Sail Sommier

## Letto imbottito con giroletto H. 15 / 25

Upholstered bed with bed frame H. 15 / 25

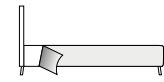

**Sfoderabile**  
Removable cover

**Non realizzabile in similpelle**  
Not available in synthetic leather



## Giroletto H. 15 senza rete

Bed frame H. 15 without bed base

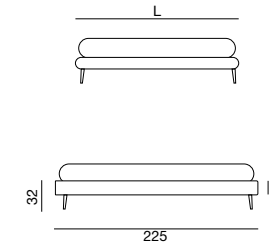

Dimensioni rete/materasso Bed base/ mattress size	Codice letto Bed code	H.L.P.	Tessuti - Fabrics				Pelle - Leather			Tessuto cliente L./H. C.O.M. fabric L./H.	m <sup>3</sup>	kg
			Cat. B	Cat. C/D	Cat. Must	Cat. K	Cat. E	Cat. Plus	Cat. Luxury			
<b>200x200</b>	223205J3I	118x <b>226</b> x225								3,70/1,40	0,38	75
<b>193x203</b>	22319KJ3I	118x <b>226</b> x228								3,70/1,40	0,38	69
<b>180x200</b>	223185J3I	118x <b>206</b> x225								3,55/1,40	0,35	66
<b>170x200</b>	223175J3I	118x <b>188</b> x225								3,45/1,40	0,33	63
<b>160x200</b>	223165J3I	118x <b>188</b> x225								3,45/1,40	0,33	63
<b>153x203</b>	22315QJ3I	118x <b>188</b> x228								3,45/1,40	0,33	63

Letto per rete o materasso profondo 190 cm nessuna maggiorazione. Con profondità 210 cm maggiorazione (escluso misure 153x203 e 193x203)  
Bed for bed base or mattress with length 190 cm, no extra charge. With length 210 cm, extra charge (excluded dimensions 153x203 and 193x203)

**Prezzi per differenza rispetto al piede di serie**  
Prices difference from the standard feet

**Nella versione in pelle testiera e giroletto hanno una o più cuciture in base alla dimensione della concia**  
In the leather version, the headboard and bed frame have one or more seams based on the size of the tanned leather

▲ Coppia ruote a richiesta  
Pair of wheels on request

	W	M	T	F	K	V	L	X	Z	H	B
	Bianco	Madreperla	Tortora	Fumo	Noce canaletto	Termocotto	Alluminio lucido	Brown Bronze	Grafite	Black nichel	Nero opaco
<b>H. 15</b>											
<b>H. 25</b>											



Cod. **PIE69Z Grafite**  
H. 17

Per rivestimento supplementare vedi pag. 189  
For additional cover see page 189

Per reti ad appoggio vedi pag. 252  
For bed bases see page 252

Per la scelta del materasso vedi pag. 235  
For the choice of mattress see page 235

Per altri giroletti consulta la pagina seguente →  
For other bed frames see the following page

<b>LAVORAZIONI SU MISURA</b> CUSTOM MADE	Modifica altezza passo 5 cm Change in Height 5 cm pitch	Modifica lunghezza passo 5 cm Change in Length 5 cm pitch	Modifica larghezza passo 5 cm Change in Width 5 cm pitch	<b>Rete 195 o 205</b> <b>Rete strutturale</b> Bed base 195 or 205 Structural bed base	<b>Rete 195 o 205</b> <b>Box contenitore</b> <b>NO A-BOX</b> Bed base 195 or 205 Storage box NO A-BOX	<b>Rete 195 o 205</b> <b>Letto senza rete</b> Bed base 195 or 205 Bed without bed base	<b>Rete a filo longone</b> <b>Rete strutturale</b> Bed base flushed with bed frame Bed without bed base	<b>Rete a filo longone</b> <b>Box contenitore</b> Bed base flushed with bed frame Storage box	<b>Rete a filo longone</b> <b>Letto senza rete</b> Bed base flushed with bed frame Bed without bed base

Per le tempistiche di consegna su lavorazioni a misura contattare l'Azienda / To learn about delivery times for customizations, please contact the company



**Giroletto H. 15 A- (senza rete)**

Bed frame H. 15 A- (without bed base)

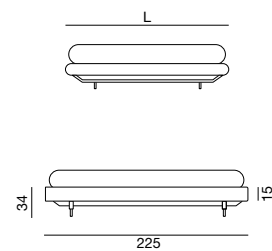

Dimensioni rete/materasso Bed base/ mattress size	Codice letto Bed code	H.L.P.	Tessuti - Fabrics				Pelle - Leather			Tessuto cliente L./H. C.O.M. fabric L./H.	m³	kg
			Cat. B	Cat. C/D	Cat. Must	Cat. K	Cat. E	Cat. Plus	Cat. Luxury			
<b>193x203</b>	22319KJ3A	118x <b>226</b> x228								3,70/1,40	0,38	75
<b>180x200</b>	223185J3A	118x <b>206</b> x225								3,55/1,40	0,35	69
<b>160x200</b>	223165J3A	118x <b>188</b> x225								3,45/1,40	0,33	63
<b>153x203</b>	22315QJ3A	118x <b>188</b> x228								3,45/1,40	0,33	63

Letto per rete o materasso profondo 190 cm nessuna maggiorazione. Con profondità 210 cm maggiorazione (escluso misure 153x203 e 193x203)  
Bed for bed base or mattress with length 190 cm, no extra charge. With length 210 cm, extra charge (excluded dimensions 153x203 and 193x203)

Per rivestimento supplementare vedi pag. 189  
For additional cover see page. 189

Per reti ad appoggio vedi pag. 252  
For bed bases see page 252

Per la scelta del materasso vedi pag. 235  
For the choice of mattress see page 235

**Giroletto H. 15 A-Box con box contenitore (rete Ortopedic Plus)**

Bed frame H. 15 A-Box with storage (Ortopedic Plus bed base)

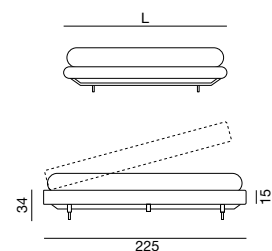

Dimensioni rete/materasso Bed base/ mattress size	Codice letto Bed code	H.L.P.	Tessuti - Fabrics				Pelle - Leather			Tessuto cliente L./H. C.O.M. fabric L./H.	m³	kg
			Cat. B	Cat. C/D	Cat. Must	Cat. K	Cat. E	Cat. Plus	Cat. Luxury			
<b>193x203</b>	22319KJ3A KBTAB019K	34x <b>226</b> x228								3,70/1,40	0,65	115
<b>180x200</b>	223185J3A KBTAB0185	34x <b>206</b> x225								3,55/1,40	0,51	101
<b>160x200</b>	223165J3A KBTAB0165	34x <b>188</b> x225								3,45/1,40	0,49	96
<b>153x203</b>	22315QJ3A KBTAB015Q	34x <b>181</b> x228								3,45/1,40	0,49	96

Letto per rete o materasso profondo 190 cm nessuna maggiorazione. Con profondità 210 cm maggiorazione (escluso misure 153x203 e 193x203)  
Bed for bed base or mattress with length 190 cm, no extra charge. With length 210 cm, extra charge (excluded dimensions 153x203 and 193x203)

Box contenitore: scheda tecnica e accessori vedi pag. 23-26  
Technical Sheet storage box and accessories see page 23-26

Per rivestimento supplementare vedi pag. 189  
For additional cover see page. 189

Per box contenitore con rete non di serie vedi pag. 25  
For storage box with no standard bed base see page 25

Per la scelta del materasso vedi pag. 235  
For the choice of mattress see page 235

**Giroletto H. 25 senza rete**

Bed frame H. 25 without bed base

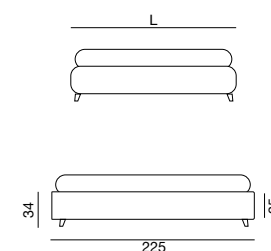

Dimensioni rete/materasso Bed base/ mattress size	Codice letto Bed code	H.L.P.	Tessuti - Fabrics				Pelle - Leather			Tessuto cliente L./H. C.O.M. fabric L./H.	m³	kg
			Cat. B	Cat. C/D	Cat. Must	Cat. K	Cat. E	Cat. Plus	Cat. Luxury			
<b>200x200</b>	223205J7N	117x <b>226</b> x225								3,70/1,40	0,38	75
<b>193x203</b>	22319KJ7N	117x <b>226</b> x228								3,70/1,40	0,38	69
<b>180x200</b>	223185J7N	117x <b>206</b> x225								3,55/1,40	0,35	66
<b>170x200</b>	223175J7N	117x <b>188</b> x225								3,45/1,40	0,33	63
<b>160x200</b>	223165J7N	117x <b>188</b> x225								3,45/1,40	0,33	63
<b>153x203</b>	22315QJ7N	117x <b>188</b> x228								3,45/1,40	0,33	63

Letto per rete o materasso profondo 190 cm nessuna maggiorazione. Con profondità 210 cm maggiorazione (escluso misure 153x203 e 193x203)  
Bed for bed base or mattress with length 190 cm, no extra charge. With length 210 cm, extra charge (excluded dimensions 153x203 and 193x203)



Cod. **PIE38 Madreperla H. 10**

Per rivestimento supplementare vedi pag. 189  
For additional cover see page. 189

Per reti ad appoggio vedi pag. 252  
For bed bases see page 252

Per la scelta del materasso vedi pag. 235  
For the choice of mattress see page 235

**Giroletto H. 25 con box contenitore (rete Ortopedic Plus)**

Bed frame H. 25 with storage (Ortopedic Plus bed base)

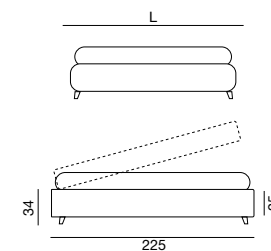

Dimensioni rete/materasso Bed base/ mattress size	Codice letto Bed code	H.L.P.	Tessuti - Fabrics				Pelle - Leather			Tessuto cliente L./H. C.O.M. fabric L./H.	m³	kg
			Cat. B	Cat. C/D	Cat. Must	Cat. K	Cat. E	Cat. Plus	Cat. Luxury			
<b>200x200</b>	223205J7N KBT800205	117x <b>226</b> x225								3,70/1,40	0,68	119
<b>193x203</b>	22319KJ7N KBT80019K	117x <b>226</b> x228								3,70/1,40	0,65	115
<b>180x200</b>	223185J7N KBT800185	117x <b>206</b> x225								3,55/1,40	0,51	101
<b>170x200</b>	223175J7N KBT800175	117x <b>188</b> x225								3,45/1,40	0,49	96
<b>160x200</b>	223165J7N KBT800165	117x <b>188</b> x225								3,45/1,40	0,49	96
<b>153x203</b>	22315QJ7N KBT80015Q	117x <b>188</b> x228								3,45/1,40	0,49	96

Letto per rete o materasso profondo 190 cm nessuna maggiorazione. Con profondità 210 cm maggiorazione (escluso misure 153x203 e 193x203)  
Bed for bed base or mattress with length 190 cm, no extra charge. With length 210 cm, extra charge (excluded dimensions 153x203 and 193x203)



Cod. **PIE38 Madreperla H. 10**

Box contenitore: scheda tecnica e accessori vedi pag. 23-26  
Technical Sheet storage box and accessories see page 23-26

Per rivestimento supplementare vedi pag. 189  
For additional cover see page. 189

Per box contenitore con rete non di serie vedi patella fine listino letti  
For storage box with no standard bed base see at the end of bed price list (inside folding cover)

Per la scelta del materasso vedi pag. 235  
For the choice of mattress see page 235

# Sommier Contract Table

## Letto imbottito con giroletto H. 22

Upholstered bed with bed frame H. 22

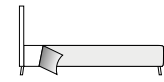

**Sfoderabile**  
Removable cover



## Giroletto H. 22

Bed frame H. 22

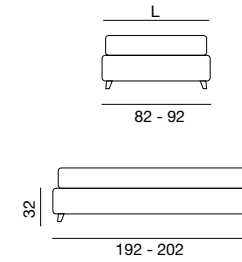

Dimensioni rete/materasso Bed base/ mattress size	Codice letto Bed code	H.L.P.	Tessuti - Fabrics				Pelle - Leather			Tessuto cliente L./H. C.O.M. fabric L./H.	m <sup>3</sup>	kg
			Cat. B	Cat. C/D	Cat. Must	Cat. K	Cat. E	Cat. Plus	Cat. Luxury			
<b>80x200</b>	22608505N	32x <b>82</b> x202								2,50/1,40	0,65	24
<b>90x200</b>	22609505N	32x <b>92</b> x202								2,50/1,40	0,65	24

Per materasso da 190 nessuna maggiorazione. Con profondità 210 cm maggiorazione  
For mattress with length 190 cm, no extra charge. With length 210 cm, extra charge

### Prezzi per differenza rispetto al piede di serie

Prices difference from the standard feet

Nella versione in pelle testiera e giroletto hanno una o più cuciture in base alla dimensione della concia  
In the leather version, the headboard and bed frame have one or more seams based on the size of the tanned leather

▲ Coppia ruote a richiesta  
Pair of wheels on request

	W	M	T	F	K	V	L	X	Z	H	B
<b>PIE38</b>											
<b>H. 10</b>											
<b>PIE3D</b>											
<b>H. 10</b>											
<b>PIE4D</b>											
<b>H. 12</b>											



Per rivestimento supplementare vedi pag. 189  
For additional cover see page 189

Per la scelta del materasso vedi pag. 235  
For the choice of mattress see page 235

<b>LAVORAZIONI SU MISURA</b> CUSTOM MADE	Modifica altezza passo 5 cm Change in Height 5 cm pitch	Modifica lunghezza passo 5 cm Change in Length 5 cm pitch	Modifica larghezza passo 5 cm Change in Width 5 cm pitch	<b>Rete 195 o 205</b> <b>Rete strutturale</b> Bed base 195 or 205 Structural bed base	<b>Rete 195 o 205</b> <b>Box contenitore</b> <b>NO A-BOX</b> Bed base 195 or 205 Storage box NO A-BOX	<b>Rete 195 o 205</b> <b>Letto senza rete</b> Bed base 195 or 205 Bed without bed base	<b>Rete a filo longone</b> <b>Rete strutturale</b> Bed base flushed with bed frame Bed without bed base	<b>Rete a filo longone</b> <b>Box contenitore</b> Bed base flushed with bed frame Storage box	<b>Rete a filo longone</b> <b>Letto senza rete</b> Bed base flushed with bed frame Bed without bed base
	NO	NO	NO	NO	NO	NO	NO	NO	NO

Per le tempistiche di consegna su lavorazioni a misura contattare l'Azienda / To learn about delivery times for customizations, please contact the company



## Box spring





**Che cos'è un letto box spring?**

Box spring è un letto che al posto delle classiche reti a doghe presenta un telaio a molle. Il materasso vero e proprio poggia su questa base. Ti sembra tutto troppo complicato? Ecco allora la nostra definizione: non hai mai dormito così bene! Soprattutto se scegli un materasso con nucleo a molle. L'unione del materasso di base a molle insacchettate e del secondo materasso regala la sensazione più paradisiaca che tu possa immaginare!



**What is a box spring bed?**

*Box spring beds are beds that have a spring structure instead of the classic slatted bed base. The mattress lies on this base. Does all this seem too complicated to you? So, here's our explanation: You've never slept so well! The combination of a pocket spring structure with a second mattress gives you the most heavenly feeling you can imagine!*

**Che cosa significa letto box spring?**

1 "Box spring" in inglese significa "molla". Quindi, un letto box spring è un letto che regala il massimo comfort tramite la sovrapposizione di diversi strati a molle. Ma il termine "box spring" si riferisce soprattutto al supporto di base, dotato di molle insacchettate. Su di esso viene appoggiato il secondo materasso, ricoperto a sua volta dal cosiddetto topper.

**What does box spring bed mean?**

1 *A box spring is a bed that offers maximum comfort thanks to the overlapping of different layers of springs. But the name "box spring" refers mainly to the basic support, equipped with pocket springs. The second mattress is placed on it, covered with a topper.*

2 Consigliamo l'uso del materasso a molle insacchettate, ma a seconda delle specifiche esigenze può accogliere qualunque tipo di materasso (vedi pag. 235).

2 *We recommend the use of pocket spring mattresses, but depending on specific needs, it can accommodate any type of mattress (see page 235).*

3 L'ideale è ricoprire questo secondo materasso con un topper, cioè un materasso sottile in Memoryfoam a cellula aperta con rivestimento sfoderabile e lavabile a 60°C, che costituisce la superficie dove distendersi (vedi pag. 251). Un letto box spring è dotato di gambe che permettono all'aria di circolare in maniera ottimale. I vari strati di materassi rendono il sistema box spring molto alto ed estremamente comodo.

3 *It is ideal to cover this second mattress with a topper, i. H. a thin mattress made of open-cell memory foam with a removable cover that can be washed at 60 °C, which forms the lying surface (see page 251). A box spring bed is equipped with legs that allow optimal air circulation. The various layers of mattresses make the box spring system very high and extremely comfortable.*



4 Box spring può essere configurato anche con un rivestimento matrimoniale unico, così come il topper può essere matrimoniale. Se i due Sommier non devono essere divisi, questa è la soluzione ideale.

4 *The box spring double bed can also be configured with a one-piece cover, just like the topper can be for a double bed. If the two box springs are not to be used separately, this is the ideal solution.*

**Che struttura ha un box spring?**

5 La struttura di un letto box spring è un materasso a molle insacchettate su cui viene poggiato un secondo materasso. Il piano di appoggio è realizzato in multistrato da 30 mm e massello di faggio da 22 mm, forato per consentire l'aerazione. L'espanso è in Aquatech con densità 40. Il massello di molle è costituito da 400 molle insacchettate (80x200cm). Un sistema letto intelligente progettato per sostenere attivamente le spinte del corpo e riassorbirle nei punti giusti: solo così la muscolatura e la colonna vertebrale possono rilassarsi in modo ottimale.

Quando la pressione esercitata dal nostro peso viene distribuita omogeneamente si ottiene un'impareggiabile sensazione di leggerezza. Tutto questo accade anche indipendentemente da quale sia il peso o l'altezza della persona.

**What is the structure of a box spring?**

5 *The structure of a box spring bed is a pocket spring mattress on which a second mattress is placed. The support surface is made of 30 mm multilayer wood and 22 mm solid beech with perforations for air circulation. The foam is made of Aquatech with a density of 40. The spring block consists of 400 pocket springs (80x200 cm). An intelligent bed system that supports the body's shocks and absorbs them again in the right places: This is the only way for the muscles and spine to relax optimally. When the pressure of our weight is evenly distributed, an incomparable feeling of lightness is created. This is regardless of the weight or height of the person.*

# Box spring

**Giroletto H. 22**  
Bed frame H. 22

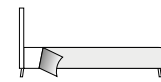

**Sfoderabile**  
Removable cover



**Prezzi per differenza rispetto al piede di serie**  
Prices difference from the standard feet

**Il box spring può essere venduto anche aggangiato ad una testata (vedi pag. 178)**  
The box spring bed can be fixed to a headboard (see page 178)

▲ Coppia ruote a richiesta  
Pair of wheels on request

	W	M	T	F	K	V	L	X	Z	H	B
	Bianco	Madreperla	Tortora	Fumo	Noce canaletto	Termocotto	Alluminio lucido	Brown Bronze	Grafite	Black nichel	Nero opaco
<b>PIE38</b>											
<b>H. 10</b>											
<b>PIE2P</b>											
<b>H. 5</b>											
<b>PIE4D</b>											
<b>H. 12</b>											

## Sommier box spring H. 22

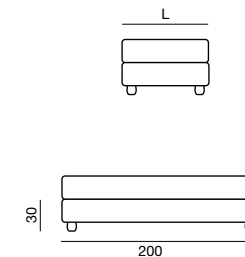

Dimensioni rete/materasso Bed base/ mattress size	Codice letto Bed code	H.L.P.	Tessuti - Fabrics				Pelle - Leather			Tessuto cliente L./H. C.O.M. fabric L./H.	m <sup>3</sup>	kg
			Cat. B	Cat. C/D	Cat. Must	Cat. K	Cat. E	Cat. Plus	Cat. Luxury			
<b>120x200</b>	223125BSN	30x120x200								2,70/1,40	0,92	42
<b>100x200</b>	223105BSN	30x100x200								2,70/1,40	0,64	42
<b>90x200</b>	223095BSN	30x90x200								2,30/1,40	0,52	42
<b>80x200</b>	223085BSN	30x80x200								2,20/1,40	0,52	37

Per materasso da 190 nessuna maggiorazione. Con profondità 210 cm maggiorazione  
For mattress with length 190 cm, no extra charge. With length 210 cm, extra charge

Per la misura da 180x200, si uniscono due sommier box spring da 90x200  
For the 180x200 size, two sommier box spring 90x200 are joined

Per la misura da 160x200, si uniscono due sommier box spring da 80x200  
For the 160x200 size, two sommier box spring 80x200 are joined



Cod. **PIE38 Madreperla**  
**H. 10**



Per rivestimento supplementare vedi pag. 190  
For additional cover see page. 190



Per la scelta del materasso vedi pag. 235  
For the choice of mattress see page 235



# Box spring con testiera

**Giroletto H. 22**  
Bed frame H. 22

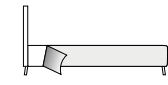

**Sfoderabile**  
Removable cover



**Prezzi per differenza rispetto al piede di serie**  
Prices difference from the standard feet

▲ Coppia ruote a richiesta  
Pair of wheels on request

	W	M	T	F	K	V	L	X	Z	H	B
<b>PIE38</b>											
<b>H. 10</b>											
<b>PIE2P</b>											
<b>H. 5</b>											
<b>PIE4D</b>											
<b>H. 12</b>											

**Schema di montaggio box spring con testiera**  
Assembly instructions for box spring with headboard



**Ada box spring - Giroletto H. 22**  
Ada box spring - Bed frame H. 22

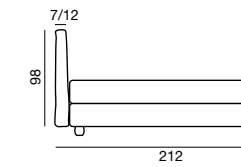
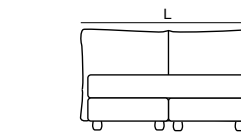

Cod. **PIE38 Madreperla**  
**H. 10**



**La testiera sborda sempre dal BOX SPRING**  
I piedi centrali possono essere nascosti  
Headboard always wider than box spring  
The central feet can be placed more backwards



Per la scelta del materasso vedi pag. 235  
For the choice of mattress see page 235

**Blanca box spring - Giroletto H. 22**  
Blanca box spring - Bed frame H. 22

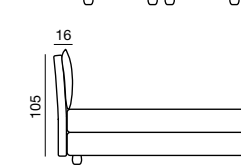
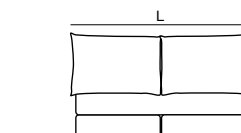

Cod. **PIE38 Madreperla**  
**H. 10**



**La testiera sborda sempre dal BOX SPRING**  
I piedi centrali possono essere nascosti  
Headboard always wider than box spring  
The central feet can be placed more backwards



Per la scelta del materasso vedi pag. 235  
For the choice of mattress see page 235



**Dread box spring - Giroletto H. 22**

Dread box spring - Bed frame H. 22

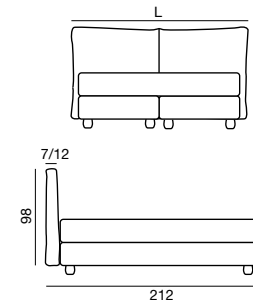

Dimensioni rete/materasso Bed base/ mattress size	Codice letto Bed code	H.L.P.	Tessuti - Fabrics				Pelle - Leather			Tessuto cliente L./H. C.O.M. fabric L./H.	m <sup>3</sup>	kg
			Cat. B	Cat. C/D	Cat. Must	Cat. K	Cat. E	Cat. Plus	Cat. Luxury			
<b>180x200</b>	144185BSN	98x <b>201</b> x212								7,70/1,40	1,53	121
<b>160x200</b>	144165BSN	98x <b>183</b> x212								7,20/1,40	1,51	111
<b>90x200</b>	144095BSN	98x <b>113</b> x212								5,10/1,40	0,78	73

Letto per rete o materasso profondo 190 cm nessuna maggiorazione. Con profondità 210 cm maggiorazione  
Bed for bed base or mattress with length 190 cm, no extra charge. With length 210 cm, extra charge

Rivestimento giroletto unico su 180 e 160 maggiorazione  
Bed frame cover in one piece on size 180 and 160



**La testiera sborda sempre dal BOX SPRING  
I piedi centrali possono essere nascosti**  
Headboard always wider than box spring  
The central feet can be placed more backwards



Cod. **PIE38 Madreperla H. 10**



Per la scelta del materasso vedi pag. 235  
For the choice of mattress see page 235

**Max Alto box spring - Giroletto H. 22**

Max Alto box spring - Bed frame H. 22

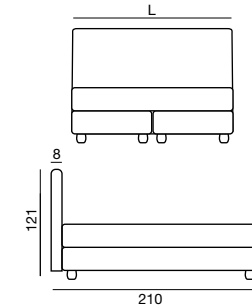

Dimensioni rete/materasso Bed base/ mattress size	Codice letto Bed code	H.L.P.	Tessuti - Fabrics				Pelle - Leather			Tessuto cliente L./H. C.O.M. fabric L./H.	m <sup>3</sup>	kg
			Cat. B	Cat. C/D	Cat. Must	Cat. K	Cat. E	Cat. Plus	Cat. Luxury			
<b>180x200</b>	18P185BSN	121x <b>182</b> x210								7,70/1,40	1,32	103
<b>160x200</b>	18P165BSN	121x <b>162</b> x210								7,20/1,40	1,31	97
<b>90x200</b>	18P095BSN	121x <b>91</b> x210								5,10/1,40	0,79	61

Letto per rete o materasso profondo 190 cm nessuna maggiorazione. Con profondità 210 cm maggiorazione  
Bed for bed base or mattress with length 190 cm, no extra charge. With length 210 cm, extra charge

Rivestimento giroletto unico su 180 e 160 maggiorazione  
Bed frame cover in one piece on size 180 and 160



**La testiera sborda sempre dal BOX SPRING  
I piedi centrali possono essere nascosti**  
Headboard always wider than box spring  
The central feet can be placed more backwards



Cod. **PIE38 Madreperla H. 10**



Per la scelta del materasso vedi pag. 235  
For the choice of mattress see page 235

**Max box spring - Giroletto H. 22**

Max box spring - Bed frame H. 22

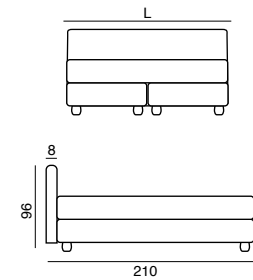

Dimensioni rete/materasso Bed base/ mattress size	Codice letto Bed code	H.L.P.	Tessuti - Fabrics				Pelle - Leather			Tessuto cliente L./H. C.O.M. fabric L./H.	m <sup>3</sup>	kg
			Cat. B	Cat. C/D	Cat. Must	Cat. K	Cat. E	Cat. Plus	Cat. Luxury			
<b>180x200</b>	186185BSN	96x <b>182</b> x210								7,70/1,40	1,32	104
<b>160x200</b>	186165BSN	96x <b>162</b> x210								7,20/1,40	1,31	97
<b>90x200</b>	186095BSN	96x <b>91</b> x210								5,10/1,40	0,80	62

Letto per rete o materasso profondo 190 cm nessuna maggiorazione. Con profondità 210 cm maggiorazione  
Bed for bed base or mattress with length 190 cm, no extra charge. With length 210 cm, extra charge

Rivestimento giroletto unico su 180 e 160 maggiorazione  
Bed frame cover in one piece on size 180 and 160



**La testiera sborda sempre dal BOX SPRING  
I piedi centrali possono essere nascosti**  
Headboard always wider than box spring  
The central feet can be placed more backwards



Cod. **PIE38 Madreperla H. 10**



Per la scelta del materasso vedi pag. 235  
For the choice of mattress see page 235

**Max Capitonné Alto box spring - Giroletto H. 22**

Max Capitonné Alto box spring - Bed frame H. 22

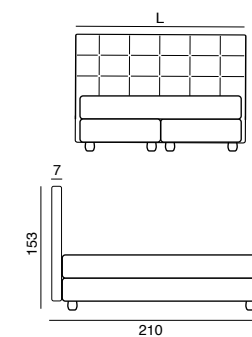

Dimensioni rete/materasso Bed base/ mattress size	Codice letto Bed code	H.L.P.	Tessuti - Fabrics				Pelle - Leather			Tessuto cliente L./H. C.O.M. fabric L./H.	m <sup>3</sup>	kg
			Cat. B	Cat. C/D	Cat. Must	Cat. K	Cat. E	Cat. Plus	Cat. Luxury			
<b>180x200</b>	18C185BSN	153x <b>185</b> x210								8,80/1,40	1,39	120
<b>160x200</b>	18C165BSN	144x <b>177</b> x210								8,25/1,40	1,39	120

Letto per rete o materasso profondo 190 cm nessuna maggiorazione. Con profondità 210 cm maggiorazione  
Bed for bed base or mattress with length 190 cm, no extra charge. With length 210 cm, extra charge

Rivestimento giroletto unico su 180 e 160 maggiorazione  
Bed frame cover in one piece on size 180 and 160



**La testiera sborda sempre dal BOX SPRING  
I piedi centrali possono essere nascosti**  
Headboard always wider than box spring  
The central feet can be placed more backwards



Cod. **PIE38 Madreperla H. 10**



Per la scelta del materasso vedi pag. 235  
For the choice of mattress see page 235

**Max Capitoné Basso box spring - Giroletto H. 22**

Max Capitoné Basso box spring - Bed frame H. 22

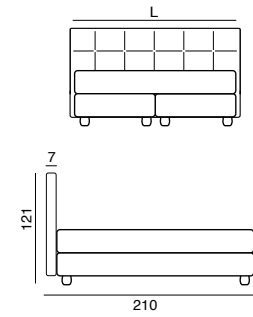

Dimensioni rete/materasso Bed base/ mattress size	Codice letto Bed code	H.L.P.	Tessuti - Fabrics				Pelle - Leather			Tessuto cliente L./H. C.O.M. fabric L./H.	m³	kg
			Cat. B	Cat. C/D	Cat. Must	Cat. K	Cat. E	Cat. Plus	Cat. Luxury			
<b>180x200</b>	18D185BSN	121x <b>195</b> x210								7,80/1,40	1,39	122
<b>160x200</b>	18D165BSN	115x <b>177</b> x210								7,20/1,40	1,39	122
<b>90x200</b>	18D095BSN	96x <b>107</b> x210								4,70/1,40	1,39	122

Letto per rete o materasso profondo 190 cm nessuna maggiorazione. Con profondità 210 cm maggiorazione  
Bed for bed base or mattress with length 190 cm, no extra charge. With length 210 cm, extra charge

Rivestimento giroletto unico su 180 e 160 maggiorazione  
Bed frame cover in one piece on size 180 and 160



**La testiera sborda sempre dal BOX SPRING  
I piedi centrali possono essere nascosti**  
Headboard always wider than box spring  
The central feet can be placed more backwards



Cod. **PIE38 Madreperla**  
**H. 10**



Per la scelta del materasso vedi pag. 235  
For the choice of mattress see page 235

**Tommy Capitoné box spring - Giroletto H. 22**

Tommy Capitoné box spring -  
Bed frame H. 22

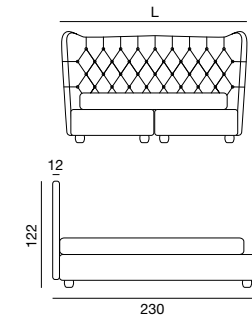

Dimensioni rete/materasso Bed base/ mattress size	Codice letto Bed code	H.L.P.	Tessuti - Fabrics				Pelle - Leather			Tessuto cliente L./H. C.O.M. fabric L./H.	m³	kg
			Cat. B	Cat. C/D	Cat. Must	Cat. K	Cat. E	Cat. Plus	Cat. Luxury			
<b>180x200</b>	230185BSN	122x <b>215</b> x224								9,60/1,40	1,39	120
<b>160x200</b>	230165BSN	122x <b>197</b> x224								8,95/1,40	1,39	120

Letto per rete o materasso profondo 190 cm nessuna maggiorazione. Con profondità 210 cm maggiorazione  
Bed for bed base or mattress with length 190 cm, no extra charge. With length 210 cm, extra charge

Rivestimento giroletto unico su 180 e 160 maggiorazione  
Bed frame cover in one piece on size 180 and 160



**La testiera sborda sempre dal BOX SPRING  
I piedi centrali possono essere nascosti**  
Headboard always wider than box spring  
The central feet can be placed more backwards



Cod. **PIE38 Madreperla**  
**H. 10**



Per la scelta del materasso vedi pag. 235  
For the choice of mattress see page 235

**Thomas box spring - Giroletto H. 22**

Thomas box spring - Bed frame H. 22

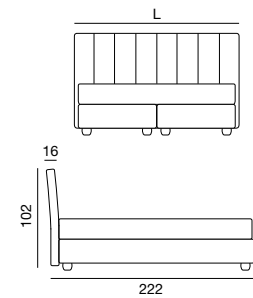

Dimensioni rete/materasso Bed base/ mattress size	Codice letto Bed code	H.L.P.	Tessuti - Fabrics				Pelle - Leather			Tessuto cliente L./H. C.O.M. fabric L./H.	m³	kg
			Cat. B	Cat. C/D	Cat. Must	Cat. K	Cat. E	Cat. Plus	Cat. Luxury			
<b>180x200</b>	231185BSN	100x <b>198</b> x222								7,70/1,40	1,32	104
<b>160x200</b>	231165BSN	100x <b>176</b> x222								7,20/1,40	1,31	97
<b>90x200</b>	231095BSN	100x <b>110</b> x222								5,10/1,40	0,80	62

Letto per rete o materasso profondo 190 cm nessuna maggiorazione. Con profondità 210 cm maggiorazione  
Bed for bed base or mattress with length 190 cm, no extra charge. With length 210 cm, extra charge

Rivestimento giroletto unico su 180 e 160 maggiorazione  
Bed frame cover in one piece on size 180 and 160



**La testiera sborda sempre dal BOX SPRING  
I piedi centrali possono essere nascosti**  
Headboard always wider than box spring  
The central feet can be placed more backwards



Cod. **PIE38 Madreperla**  
**H. 10**



Per la scelta del materasso vedi pag. 235  
For the choice of mattress see page 235

## Rivestimenti

Boiserie / Testiere a parete / Sommier / Box spring

*Covers Wall panels / Wall mounted headboards / Sommier / Box spring*





## Rivestimenti boiserie

### Covers Wall panels

#### Boiserie Marlene



	Dimensioni Size	Cod. rivestim. Cover code	Tessuti - Fabrics				Pelle - Leather			m <sup>3</sup>	kg
			Cat. B	Cat. C/D	Cat. Must	Cat. K	Cat. E	Cat. Plus	Cat. Luxury		
Liscio Smooth	<b>97,5</b>	B81097038								0,02	0
	<b>65</b>	B81065038								0,02	0
Soft	<b>97,5</b>	B7S097038								0,02	0
	<b>65</b>	B7S065038								0,02	0

#### Boiserie Set Slim



	Dimensioni Size	Cod. rivestim. Cover code	Tessuti - Fabrics				Pelle - Leather			m <sup>3</sup>	kg
			Cat. B	Cat. C/D	Cat. Must	Cat. K	Cat. E	Cat. Plus	Cat. Luxury		
Spessore 5 H. 17 Thickness 5 H. 17	<b>60</b>	B7I060017								0,02	0
	<b>85</b>	B7I085017								0,02	0
	<b>100</b>	B7I100017								0,02	0
	<b>120</b>	B7I120017								0,02	0
	<b>135</b>	B7I135017								0,02	0
	<b>180</b>	B7I180017								0,02	1
	<b>200</b>	B7I200017								0,02	1

#### Boiserie Set Slim

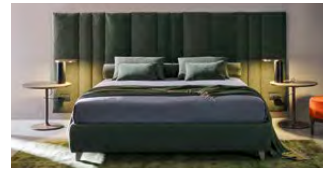

	Dimensioni Size	Cod. rivestim. Cover code	Tessuti - Fabrics				Pelle - Leather			m <sup>3</sup>	kg
			Cat. B	Cat. C/D	Cat. Must	Cat. K	Cat. E	Cat. Plus	Cat. Luxury		
Spessore 5 H. 35 Thickness 5 H. 35	<b>60</b>	B7I060035								0,02	0
	<b>85</b>	B7I085035								0,02	0
	<b>100</b>	B7I100035								0,02	1
	<b>120</b>	B7I120035								0,02	1
	<b>135</b>	B7I135035								0,02	1
	<b>180</b>	B7I180035								0,02	1
	<b>200</b>	B7I200035								0,02	1

#### Boiserie Oscar barré



	Dimensioni Size	Cod. rivestim. Cover code	Tessuti - Fabrics				Pelle - Leather			m <sup>3</sup>	kg
			Cat. B	Cat. C/D	Cat. Must	Cat. K	Cat. E	Cat. Plus	Cat. Luxury		
Spessore 8 H. 110 Thickness 8 H. 110	<b>180x200</b>	B7Y325								0,02	1
	<b>160x200</b>	B7Y275								0,02	1

## Rivestimenti testiere a parete

### Covers wall mounted headboards

#### Dread



	Dimensioni rete/materasso Bed base/ mattress size	Cod. rivestim. Cover code	Tessuti - Fabrics				Pelle - Leather			m <sup>3</sup>	kg
			Cat. B	Cat. C/D	Cat. Must	Cat. K	Cat. E	Cat. Plus	Cat. Luxury		
Testiera a parete Wall mounted headboard	<b>180x200</b>	A44180TAN								0,02	2
	<b>160x200</b>	A44160TAN								0,02	2
	<b>140x200</b>	A44140TAN								0,02	2
	<b>120x200</b>	A44120TAN								0,02	2
	<b>90x200</b>	A44090TAN								0,02	1

#### Max



	Dimensioni rete/materasso Bed base/ mattress size	Cod. rivestim. Cover code	Tessuti - Fabrics				Pelle - Leather			m <sup>3</sup>	kg
			Cat. B	Cat. C/D	Cat. Must	Cat. K	Cat. E	Cat. Plus	Cat. Luxury		
Testiera a parete Wall mounted headboard	<b>200x200</b>	A86200TAN								0,02	1
	<b>180x200</b>	A86180TAN								0,02	1
	<b>160x200</b>	A86160TAN								0,02	1
	<b>140x200</b>	A86140TAN								0,02	1
	<b>120x200</b>	A86120TAN								0,02	1
	<b>90x200</b>	A86090TAN								0,02	1

#### Max Alto



	Dimensioni rete/materasso Bed base/ mattress size	Cod. rivestim. Cover code	Tessuti - Fabrics				Pelle - Leather			m <sup>3</sup>	kg
			Cat. B	Cat. C/D	Cat. Must	Cat. K	Cat. E	Cat. Plus	Cat. Luxury		
Testiera a parete Wall mounted headboard	<b>200x200</b>	A8P200TAN								0,02	2
	<b>180x200</b>	A8P180TAN								0,02	2
	<b>160x200</b>	A8P160TAN								0,02	2
	<b>140x200</b>	A8P140TAN								0,02	2
	<b>120x200</b>	A8P120TAN								0,02	2
	<b>90x200</b>	A8P090TAN								0,02	2

#### Medea



	Dimensioni rete/materasso Bed base/ mattress size	Cod. rivestim. Cover code	Tessuti - Fabrics				Pelle - Leather			m <sup>3</sup>	kg
			Cat. B	Cat. C/D	Cat. Must	Cat. K	Cat. E	Cat. Plus	Cat. Luxury		
Testiera a parete Wall mounted headboard	<b>180x200</b>	A92180TAN								0,02	2
	<b>160x200</b>	A92160TAN								0,02	2
	<b>140x200</b>	A92140TAN								0,02	2
	<b>120x200</b>	A92120TAN								0,02	2
	<b>90x200</b>	A92090TAN								0,02	1

## Rivestimenti Sommier Covers Sommier

### Ada Sommier



	Dimensioni rete/materasso Bed base/ mattress size	Cod. rivestim. Cover code	Tessuti - Fabrics				Pelle - Leather			m <sup>3</sup>	kg
			Cat. B	Cat. C/D	Cat. Must	Cat. K	Cat. E	Cat. Plus	Cat. Luxury		
Rivestimento Sommier Cover Sommier	<b>200x200</b>	B23205...								0,02	2
	<b>193x203</b>	B2319K...								0,02	2
	<b>180x200</b>	B23185...								0,02	2
	<b>160x200</b>	B23165...								0,02	2
	<b>153x203</b>	B2315Q...								0,02	2
	<b>120x200</b>	B23125...								0,02	2

### Ekeko Sommier



	Dimensioni rete/materasso Bed base/ mattress size	Cod. rivestim. Cover code	Tessuti - Fabrics				Pelle - Leather			m <sup>3</sup>	kg
			Cat. B	Cat. C/D	Cat. Must	Cat. K	Cat. E	Cat. Plus	Cat. Luxury		
Rivestimento Sommier Cover Sommier	<b>180x200</b>	B2318509N								0,02	2
	<b>160x200</b>	B2316509N								0,02	2

### Max Sommier



	Dimensioni rete/materasso Bed base/ mattress size	Cod. rivestim. Cover code	Tessuti - Fabrics				Pelle - Leather			m <sup>3</sup>	kg
			Cat. B	Cat. C/D	Cat. Must	Cat. K	Cat. E	Cat. Plus	Cat. Luxury		
Rivestimento Sommier Cover Sommier	<b>200x200</b>	B23205...								0,02	1
	<b>193x203</b>	B2319K...								0,02	1
	<b>180x200</b>	B23185...								0,02	1
	<b>170x200</b>	B23175...								0,02	1
	<b>160x200</b>	B23165...								0,02	1
	<b>153x203</b>	B2315Q...								0,02	1
	<b>140x200</b>	B23145...								0,02	1
	<b>120x200</b>	B23125...								0,02	1
	<b>100x200</b>	B23105...								0,02	1
	<b>90x200</b>	B23095...								0,02	1

## Rivestimenti Sommier Covers Sommier

### Sommier



	Dimensioni rete/materasso Bed base/ mattress size	Cod. rivestim. Cover code	Tessuti - Fabrics				Pelle - Leather			m <sup>3</sup>	kg
			Cat. B	Cat. C/D	Cat. Must	Cat. K	Cat. E	Cat. Plus	Cat. Luxury		
Rivestimento Sommier Cover Sommier	<b>200x200</b>	B23205...								0,02	1
	<b>193x203</b>	B2319K...								0,02	1
	<b>180x200</b>	B23185...								0,02	1
	<b>170x200</b>	B23175...								0,02	1
	<b>160x200</b>	B23165...								0,02	1
	<b>153x203</b>	B2315Q...								0,02	1
	<b>140x200</b>	B23145...								0,02	1
	<b>120x200</b>	B23125...								0,02	1
	<b>100x200</b>	B23105...								0,02	1
	<b>90x200</b>	B23095...								0,02	1

### Sail Sommier



	Dimensioni rete/materasso Bed base/ mattress size	Cod. rivestim. Cover code	Tessuti - Fabrics				Pelle - Leather			m <sup>3</sup>	kg
			Cat. B	Cat. C/D	Cat. Must	Cat. K	Cat. E	Cat. Plus	Cat. Luxury		
Rivestimento Sommier Cover Sommier	<b>200x200</b>	B23205J7N								0,02	1
	<b>193x203</b>	B2319KJ7N								0,02	1
	<b>180x200</b>	B23185J7N								0,02	1
	<b>170x200</b>	B23175J7N								0,02	1
	<b>160x200</b>	B23165J7N								0,02	1
<b>153x203</b>	B2315QJ7N								0,02	1	

### Sommier Contract Table



	Dimensioni rete/materasso Bed base/ mattress size	Cod. rivestim. Cover code	Tessuti - Fabrics				Pelle - Leather			m <sup>3</sup>	kg
			Cat. B	Cat. C/D	Cat. Must	Cat. K	Cat. E	Cat. Plus	Cat. Luxury		
Rivestimento Sommier Cover Sommier	<b>90x200</b>	B2609505N								0,2	2,3
	<b>80x200</b>	B2608505N								0,2	2,0

# Rivestimenti Box spring

## Covers Box spring

### Sommier box spring



	Dimensioni rete/materasso <i>Bed base/ mattress size</i>	Cod. rivestim. <i>Cover code</i>	Tessuti - <i>Fabrics</i>				Pelle - <i>Leather</i>			m <sup>3</sup>	kg
			Cat. B	Cat. C/D	Cat. Must	Cat. K	Cat. E	Cat. Plus	Cat. Luxury		
Rivestimento Sommier <i>Cover Sommier</i>	<b>120x200</b>	B23125BSN							0,3	2,5	
	<b>100x200</b>	B23105BSN							0,3	2,5	
	<b>90x200</b>	B23095BSN							0,2	2,3	
	<b>80x200</b>	B23085BSN							0,2	2,3	



**twils.it**

**Twils s.r.l.**

Via degli Olmi, 5 - 31040 Cessalto (TV)

Tel. +39 0421 469011 r.a - Fax +39 0421 327916

Tel. +39 0421 469090 uff. comm. - Tel. +39 0421 469050 uff. sped.

commerciale.italia@twils.it - export@twils.it - info@twils.it