

Tobia Sommier

Letto imbottito con giroletto H. 14 / 25

Upholstered bed with bed frame H. 14 / 25



Sfoderabile (no in pelle)

Removable cover (no leather)













Prezzi per differenza rispetto al piede di serie

Prices difference from the standard feet

Nella versione in pelle testiera e giroletto hanno una o più cuciture in base alla dimensione della concia

In the leather version, the headboard and bed frame have one or more seams based on the size of the tanned leather

▲ Coppia ruote a richiesta
Pair of wheels on request

		W	M	T	F	K	V	L	X	Z	H	B
												
		Bianco	Madreperla	Tortora	Fumo	Noce canaletto	Termocotto	Alluminio lucido	Brown Bronze	Grafite	Black nichel	Nero opaco
H. 14	PIE88											
	H. 24 H. 9%											
	PIE69Z											
	H. 17 H. 7%											
	PIE8D											
H. 24 H. 9%												
PIE8M												
H. 24 H. 9%												
PIE45Z												
H. 12 H. 4%												
PIE4D												
H. 12 H. 4%												
PIE45T												
H. 12 H. 4%												
PIE45Z												
H. 12 H. 4%												
PIE4M												
H. 12 H. 4%												
PIE38												
H. 10 H. 3%												

Non si eseguono lavorazioni su misura

Customization is not possible

Giroletto H. 14 con rete strutturale (Ortopedic)

Bed frame H. 14 with structural bed base (Orthopedic)

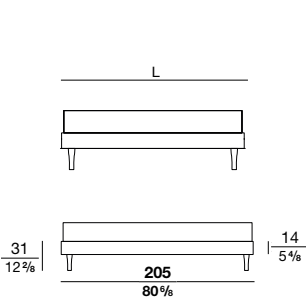

Dimensioni rete/materasso Bed base/ mattress size	Codice letto Bed code	H.L.P.	Tessuti - Fabrics				Pelle - Leather			Tessuto cliente L./H. C.O.M. fabric L./H.	m ³	kg
			Cat. B	Cat. C/D	Cat. Must	Cat. K	Cat. E	Cat. Plus	Cat. Luxury			
160x200 63x78%	223165M3N	31x 164 x205 12% x64 %x80%								6,75/1,40	0,33	45
120x200 47% x78 %	223125M3N	31x 124 x205 12% x48 %x80%								6,05/1,40	0,27	38

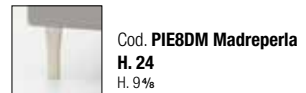

190 Letto per rete e/o materasso da 190
Bed for bed base and/or mattress 190

Per la scelta del materasso vedi pag. 285 dal listino generale
For the choice of mattress see page 285 of the main price list

Giroletto H. 25 con rete in appoggio (rete Ortopedic Plus)

Bed frame H. 25 with bed base (Orthopedic Plus bed base)

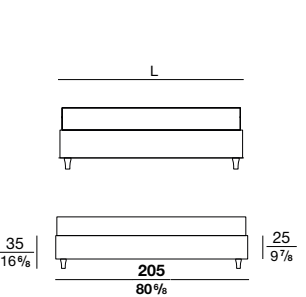

Dimensioni rete/materasso Bed base/ mattress size	Codice letto Bed code	H.L.P.	Tessuti - Fabrics				Pelle - Leather			Tessuto cliente L./H. C.O.M. fabric L./H.	m ³	kg
			Cat. B	Cat. C/D	Cat. Must	Cat. K	Cat. E	Cat. Plus	Cat. Luxury			
160x200 63x78%	223165M7N RETE03165T	35x 164 x205 13% x64 %x80%								6,75/1,40	0,30	40
120x200 47% x78 %	223125M7N RETE03125T	35x 124 x205 13% x48 %x80%								6,05/1,40	0,22	33

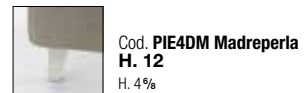

190 Letto per rete e/o materasso da 190
Bed for bed base and/or mattress 190

Per la scelta del materasso vedi pag. 285 dal listino generale
For the choice of mattress see page 285 of the main price list

Giroletto H. 25 con box contenitore (rete Ortopedic Plus)

Bed frame H. 25 with storage (Orthopedic Plus bed base)

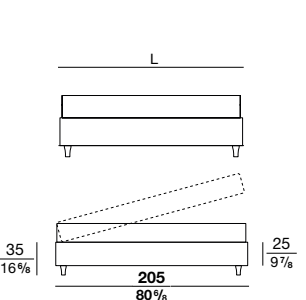

Dimensioni rete/materasso Bed base/ mattress size	Codice letto Bed code	H.L.P.	Tessuti - Fabrics				Pelle - Leather			Tessuto cliente L./H. C.O.M. fabric L./H.	m ³	kg
			Cat. B	Cat. C/D	Cat. Must	Cat. K	Cat. E	Cat. Plus	Cat. Luxury			
160x200 63x78%	223165M7N KBT80C165T	35x 164 x205 13% x64 %x80%								6,75/1,40	0,54	85
120x200 47% x78 %	223125M7N KBT80C125T	35x 124 x205 13% x48 %x80%								6,05/1,40	0,45	73

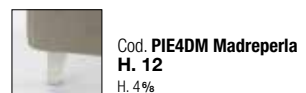

190 Letto per rete e/o materasso da 190
Bed for bed base and/or mattress 190

Per la scelta del materasso vedi pag. 285 dal listino generale
For the choice of mattress see page 285 of the main price list

Rivestimento Sommier

Covers Sommier

Dimensioni rete Bed base size	Cod. rivestim. Cover code	Tessuti - Fabrics				Pelle - Leather			Tessuto cliente L./H. C.O.M. fabric L./H.	m ³	kg
		Cat. B	Cat. C/D	Cat. Must	Cat. K	Cat. E	Cat. Plus	Cat. Luxury			
160x200 63x78%	A03165...								6,75/1,40	0,02	2,00
120x200 47% x78 %	A03125...								6,05/1,40	0,02	1,80