

file 3D



Completamente sfoderabile

- ① multistrato di legno con massello di abete e pioppo
- ② fibra di legno
- ③ cinghie elastiche da 6 /8 cm incrociate
- ④ poliuretano espanso D30 IP
- ⑤ poliuretano espanso D21 IM
- ⑥ OLISUV HV 220 gr
- ⑦ vellutino 260gr
- ⑧ OLIFLEX 250 gr
- ⑨ poliuretano espanso D75 IP
- ⑩ poliuretano espanso D25 IM
- ⑪ poliuretano espanso D35 IP
- ⑫ misto piuma d'oca e fibra siliconata
- ⑬ tessuto 100% cotone
- ⑭ espanso D30 IP
- ⑮ piuma d'oca (non presente nella versione espanso)

piedi metallo verniciati nero opaco

Attenzione: il modello T-Time è prezzoato senza i cuscini schienale. I cuscini sono da sommare alla scocca (vedi pag. 362-363).

Attention: the T-Time model is priced without the back cushions. The cushions must be added to the sofa (see page 362-363).

Completely removable cover

- ① plywood panels and poplar or pine solid wood
- ② wood fibreboard
- ③ elastic belt 6/8cm, cross-weft
- ④ polyurethane foam D30 IP
- ⑤ polyurethane foam D21 IM
- ⑥ OLISUV HV 220 gr
- ⑦ resin bonded velvet 260 gr
- ⑧ OLIFLEX 250gr
- ⑨ polyurethane foam D75 IP
- ⑩ polyurethane Foam D25 IM
- ⑪ polyurethane foam D35IP
- ⑫ washed and sterilized goose down and siliconed fiber quilted into sections
- ⑬ 100% cotton fabric
- ⑭ polyurethane foam D30 IP
- ⑮ goose feather (not included inside foam seat option)

metal feet black matt pairs

Attenzione i prezzi sono riferiti solo alle scocche. Prezzi cuscini schienali da calcolare a parte (pag. 362 - 363)

Attention, the prices refer only to the sofas. Back cushions prices to be calculated separatel (page 362 - 363)

T-Time

Divani

Sofas

Descrizione Description	Codice Code	Lato Side	Tessuti - Fabrics				Pelle - Pelle			Tessuto cliente L./H. C.O.M. fabric L./H.
			Cat. B	Cat. C/D	Cat. Must	Cat. K	Cat. E	Cat. Plus	Cat. Luxury	
Espano Foam	36MCE1N 186									8,00/1,40
Piuma Feather	36MCP1N 186									8,00/1,40
Fodera Cover	C6M...									8,00/1,40
m³ 1,20 - kg. 82			Piede legno a scomparsa Wooden feet not visible					Piedi in alluminio Aluminium foot		

Divani

Sofas

Descrizione Description	Codice Code	Lato Side	Tessuti - Fabrics				Pelle - Pelle			Tessuto cliente L./H. C.O.M. fabric L./H.
			Cat. B	Cat. C/D	Cat. Must	Cat. K	Cat. E	Cat. Plus	Cat. Luxury	
Espano Foam	36MCE1N 206									8,00/1,40
Piuma Feather	36MCP1N 206									8,00/1,40
Fodera Cover	C6M...									8,00/1,40
m³ 1,40 - kg. 92			Piede legno a scomparsa Wooden feet not visible					Piedi in alluminio Aluminium foot		

Divani

Sofas

Descrizione Description	Codice Code	Lato Side	Tessuti - Fabrics				Pelle - Pelle			Tessuto cliente L./H. C.O.M. fabric L./H.
			Cat. B	Cat. C/D	Cat. Must	Cat. K	Cat. E	Cat. Plus	Cat. Luxury	
Espano Foam	36MCE1N 226									8,10/1,40
Piuma Feather	36MCP1N 226									8,10/1,40
Fodera Cover	C6M...									8,10/1,40
m³ 1,5 - kg. 98			Piede legno a scomparsa Wooden feet not visible					Piedi in alluminio Aluminium foot		

Divani

Sofas

Descrizione Description	Codice Code	Lato Side	Tessuti - Fabrics				Pelle - Pelle			Tessuto cliente L./H. C.O.M. fabric L./H.
			Cat. B	Cat. C/D	Cat. Must	Cat. K	Cat. E	Cat. Plus	Cat. Luxury	
Espano Foam	36MCE1N 246									8,60/1,40
Piuma Feather	36MCP1N 246									8,60/1,40
Fodera Cover	C6M...									8,60/1,40
m³ 1,65 - kg. 104			Piede legno a scomparsa Wooden feet not visible					Piedi in alluminio Aluminium foot		

Divani

Sofas

Descrizione Description	Codice Code	Lato Side	Tessuti - Fabrics				Pelle - Pelle			Tessuto cliente L./H. C.O.M. fabric L./H.
			Cat. B	Cat. C/D	Cat. Must	Cat. K	Cat. E	Cat. Plus	Cat. Luxury	
Espano Foam	36MCE1N 2863C									9,90/1,40
Piuma Feather	36MCP1N 2863C									9,90/1,40
Fodera Cover	C6M...									9,90/1,40
m³ 1,90 - kg. 115			Piede legno a scomparsa Wooden feet not visible					Piedi in alluminio Aluminium foot		

Attenzione i prezzi sono riferiti solo alle scocche. Prezzi cuscini schienali da calcolare a parte (pag. 362 - 363)

Attention, the prices refer only to the sofas. Back cushions prices to be calculated separatel (page 362 - 363)

T-Time

Divani

Sofas

Descrizione Description	Codice Code	Lato Side	Tessuti - Fabrics				Pelle - Pelle			Tessuto cliente L./H. C.O.M. fabric L./H.
			Cat. B	Cat. C/D	Cat. Must	Cat. K	Cat. E	Cat. Plus	Cat. Luxury	
Espano Foam	36MCE1N 2862C									9,50/1,40
Piuma Feather	36MCP1N 2862C									9,50/1,40
Fodera Cover	C6M...									9,50/1,40
m³ 1,90 - kg. 115			Piede legno a scomparsa Wooden feet not visible					Piedi in alluminio Aluminium foot		

Laterali

Side element

Descrizione Description	Codice Code	Lato Side	Tessuti - Fabrics				Pelle - Pelle			Tessuto cliente L./H. C.O.M. fabric L./H.
			Cat. B	Cat. C/D	Cat. Must	Cat. K	Cat. E	Cat. Plus	Cat. Luxury	
Espano Foam	36MCE2S 163 36MCE2R 163	SX / LH DX / RH								6,30/1,40
Piuma Feather	36MCP2S 163 36MCP2R 163	SX / LH DX / RH								6,30/1,40
Fodera Cover	C6M...									6,30/1,40
m³ 1,05 - kg. 60			Piede legno a scomparsa Wooden feet not visible					Piedi in alluminio Aluminium foot		

Laterali

Side element

Descrizione Description	Codice Code	Lato Side	Tessuti - Fabrics				Pelle - Pelle			Tessuto cliente L./H. C.O.M. fabric L./H.
			Cat. B	Cat. C/D	Cat. Must	Cat. K	Cat. E	Cat. Plus	Cat. Luxury	
Espano Foam	36MCE2S 183 36MCE2R 183	SX / LH DX / RH								6,30/1,40
Piuma Feather	36MCP2S 183 36MCP2R 183	SX / LH DX / RH								6,30/1,40
Fodera Cover	C6M...									6,30/1,40
m³ 1,20 - kg. 70			Piede legno a scomparsa Wooden feet not visible					Piedi in alluminio Aluminium foot		

Laterali

Side element

Descrizione Description	Codice Code	Lato Side	Tessuti - Fabrics				Pelle - Pelle			Tessuto cliente L./H. C.O.M. fabric L./H.
			Cat. B	Cat. C/D	Cat. Must	Cat. K	Cat. E	Cat. Plus	Cat. Luxury	
Espano Foam	36MCE2S 203 36MCE2R 203	SX / LH DX / RH								6,70/1,40
Piuma Feather	36MCP2S 203 36MCP2R 203	SX / LH DX / RH								6,70/1,40
Fodera Cover	C6M...									6,70/1,40
m³ 1,30 - kg. 76			Piede legno a scomparsa Wooden feet not visible					Piedi in alluminio Aluminium foot		

Laterali

Side element

Descrizione Description	Codice Code	Lato Side	Tessuti - Fabrics				Pelle - Pelle			Tessuto cliente L./H. C.O.M. fabric L./H.
			Cat. B	Cat. C/D	Cat. Must	Cat. K	Cat. E	Cat. Plus	Cat. Luxury	
Espano Foam	36MCE2S 223 36MCE2R 223	SX / LH DX / RH								7,30/1,40
Piuma Feather	36MCP2S 223 36MCP2R 223	SX / LH DX / RH								7,30/1,40
Fodera Cover	C6M...									7,30/1,40
m³ 1,45 - kg. 82			Piede legno a scomparsa Wooden feet not visible					Piedi in alluminio Aluminium foot		

Attenzione i prezzi sono riferiti solo alle scocche. Prezzi cuscini schienali da calcolare a parte (pag. 362 - 363)

Attention, the prices refer only to the sofas. Back cushions prices to be calculated separatel (page 362 - 363)

T-Time

Centrali

Central elements

Descrizione Description	Codice Code	Lato Side	Tessuti - Fabrics				Pelle - Pelle			Tessuto cliente L./H. C.O.M. fabric L./H.
			Cat. B	Cat. C/D	Cat. Must	Cat. K	Cat. E	Cat. Plus	Cat. Luxury	
Espano Foam	36MCE3N 080									3,40/1,40
Piuma Feather	36MCP3N 080									3,40/1,40
Fodera Cover	C6M...									3,40/1,40
m³ 1,20 - kg. 59,98			Piede legno a scomparsa Wooden feet not visible					Piedi in alluminio Aluminium foot		

Centrali

Central elements

Descrizione Description	Codice Code	Lato Side	Tessuti - Fabrics				Pelle - Pelle			Tessuto cliente L./H. C.O.M. fabric L./H.
			Cat. B	Cat. C/D	Cat. Must	Cat. K	Cat. E	Cat. Plus	Cat. Luxury	
Espano Foam	36MCE3N 140									5,00/1,40
Piuma Feather	36MCP3N 140									5,00/1,40
Fodera Cover	C6M...									5,00/1,40
m³ 1,20 - kg. 57,15			Piede legno a scomparsa Wooden feet not visible					Piedi in alluminio Aluminium foot		

Centrali

Central elements

Descrizione Description	Codice Code	Lato Side	Tessuti - Fabrics				Pelle - Pelle			Tessuto cliente L./H. C.O.M. fabric L./H.
			Cat. B	Cat. C/D	Cat. Must	Cat. K	Cat. E	Cat. Plus	Cat. Luxury	
Espano Foam	36MCE3N 160									5,20/1,40
Piuma Feather	36MCP3N 160									5,20/1,40
Fodera Cover	C6M...									5,20/1,40
m³ 1,21 - kg. 57,63			Piede legno a scomparsa Wooden feet not visible					Piedi in alluminio Aluminium foot		

Pentangolo

Penta corner

Attenzione: non abbinabile al Pouf

Attention: cannot be combined with Pouf

Descrizione Description	Codice Code	Lato Side	Tessuti - Fabrics				Pelle - Pelle			Tessuto cliente L./H. C.O.M. fabric L./H.
			Cat. B	Cat. C/D	Cat. Must	Cat. K	Cat. E	Cat. Plus	Cat. Luxury	
Espano Foam	36MCE4N 145									7,30/1,40
Piuma Feather	36MCP4N 145									7,30/1,40
Fodera Cover	C6M...									7,30/1,40
m³ 1,40 - kg. 120			Piede legno a scomparsa Wooden feet not visible					Piedi in alluminio Aluminium foot		

Penisole

Chaise longues

Descrizione Description	Codice Code	Lato Side	Tessuti - Fabrics				Pelle - Pelle			Tessuto cliente L./H. C.O.M. fabric L./H.
			Cat. B	Cat. C/D	Cat. Must	Cat. K	Cat. E	Cat. Plus	Cat. Luxury	
Espano Foam	36MCE5S 113 36MCE5R 113	SX / LH DX / RH								5,90/1,40
Piuma Feather	36MCP5S 113 36MCP5R 113	SX / LH DX / RH								5,90/1,40
Fodera Cover	C6M...									5,90/1,40
m³ 1,15 - kg. 70			Piede legno a scomparsa Wooden feet not visible					Piedi in alluminio Aluminium foot		

Attenzione i prezzi sono riferiti solo alle scocche. Prezzi cuscini schienali da calcolare a parte (pag. 362 - 363)

Attention, the prices refer only to the sofas. Back cushions prices to be calculated separatel (page 362 - 363)

T-Time

Penisole

Chaise longues

Descrizione Description	Codice Code	Lato Side	Tessuti - Fabrics				Pelle - Pelle			Tessuto cliente L./H. C.O.M. fabric L./H.
			Cat. B	Cat. C/D	Cat. Must	Cat. K	Cat. E	Cat. Plus	Cat. Luxury	
Espano Foam	36MCE5S 133x160 36MCE5R 133x160	SX / LH DX / RH								5,90/1,40
Piuma Feather	36MCP5S 133x160 36MCP5R 133x160	SX / LH DX / RH								5,90/1,40
Fodera Cover	C6M...									5,90/1,40
m³ 1,35 - kg. 75			Piede legno a scomparsa Wooden feet not visible					Piedi in alluminio Aluminium foot		

Angolo con meridienne

Corner dormeuse

Descrizione Description	Codice Code	Lato Side	Tessuti - Fabrics				Pelle - Pelle			Tessuto cliente L./H. C.O.M. fabric L./H.
			Cat. B	Cat. C/D	Cat. Must	Cat. K	Cat. E	Cat. Plus	Cat. Luxury	
Espano Foam	36MCE7S 103x223 36MCE7R 103x223	SX / LH DX / RH								6,80/1,40
Piuma Feather	36MCP7S 103x223 36MCP7R 103x223	SX / LH DX / RH								6,80/1,40
Fodera Cover	C6M...									6,80/1,40
m³ 1,45 - kg. 80			Piede legno a scomparsa Wooden feet not visible					Piedi in alluminio Aluminium foot		

Penthouse

Penta corner

Abbinabile al Pouf

Can be combined with Footstool

Descrizione Description	Codice Code	Lato Side	Tessuti - Fabrics				Pelle - Pelle			Tessuto cliente L./H. C.O.M. fabric L./H.
			Cat. B	Cat. C/D	Cat. Must	Cat. K	Cat. E	Cat. Plus	Cat. Luxury	
Espano Foam	36MCE4S 145 36MCE4R 145	SX / LH DX / RH								5,30/1,40
Piuma Feather	36MCP4S 145 36MCP4R 145	SX / LH DX / RH								5,30/1,40
Fodera Cover	C6M...									5,30/1,40
m³ 1,40 - kg. 125			Piede legno a scomparsa Wooden feet not visible					Piedi in alluminio Aluminium foot		

Pouf

Footstool

Descrizione Description	Codice Code	Lato Side	Tessuti - Fabrics				Pelle - Pelle			Tessuto cliente L./H. C.O.M. fabric L./H.
			Cat. B	Cat. C/D	Cat. Must	Cat. K	Cat. E	Cat. Plus	Cat. Luxury	
Espano Foam	36MCE8N 103x80									2,55/1,40
Piuma Feather	36MCP8N 103x80									2,55/1,40
Fodera Cover	C6M...									2,55/1,40
m³ 0,55 - kg. 50			Piede legno a scomparsa Wooden feet not visible					Piedi in alluminio Aluminium foot		

Pouf

Footstool

Descrizione Description	Codice Code	Lato Side	Tessuti - Fabrics				Pelle - Pelle			Tessuto cliente L./H. C.O.M. fabric L./H.
			Cat. B	Cat. C/D	Cat. Must	Cat. K	Cat. E	Cat. Plus	Cat. Luxury	
Espano Foam	36MCE8N 103x103									285/140
Piuma Feather	36MCP8N 103x103									285/140
Fodera Cover	C6M...									285/140
m³ 0,52 - kg. 52			Piede legno a scomparsa Wooden feet not visible					Piedi in alluminio Aluminium foot		

Attenzione i prezzi sono riferiti solo alle scocche. Prezzi cuscini schienali da calcolare a parte (pag. 362 - 363)

Attention, the prices refer only to the sofas. Back cushions prices to be calculated separatel (page 362 - 363)

T-Time

Cuscini schienale

Back cushions



Descrizione Description	Codice Code	Lato Side	Tessuti - Fabrics				Pelle - Pelle			Tessuto cliente L./H. C.O.M. fabric L./H.
			Cat. B	Cat. C/D	Cat. Must	Cat. K	Cat. E	Cat. Plus	Cat. Luxury	
Piuma Feather	36MEPCN 70x50									0,85/1,40
Fodera Cover	C6M...									0,85/1,40

m³ 0,15 - kg. 3,7

Cuscini schienale

Back cushions



Descrizione Description	Codice Code	Lato Side	Tessuti - Fabrics				Pelle - Pelle			Tessuto cliente L./H. C.O.M. fabric L./H.
			Cat. B	Cat. C/D	Cat. Must	Cat. K	Cat. E	Cat. Plus	Cat. Luxury	
Piuma Feather	36MEPCN 80x50									0,95/1,40
Fodera Cover	C6M...									0,95/1,40

m³ 0,15 - kg. 4,3

Cuscini schienale

Back cushions



Descrizione Description	Codice Code	Lato Side	Tessuti - Fabrics				Pelle - Pelle			Tessuto cliente L./H. C.O.M. fabric L./H.
			Cat. B	Cat. C/D	Cat. Must	Cat. K	Cat. E	Cat. Plus	Cat. Luxury	
Piuma Feather	36MEPCN 90x50									1,05/1,40
Fodera Cover	C6M...									1,05/1,40

m³ 0,18 - kg. 4,8

Cuscini schienale

Back cushions

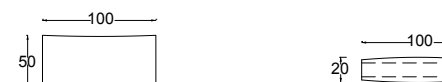

Descrizione Description	Codice Code	Lato Side	Tessuti - Fabrics				Pelle - Pelle			Tessuto cliente L./H. C.O.M. fabric L./H.
			Cat. B	Cat. C/D	Cat. Must	Cat. K	Cat. E	Cat. Plus	Cat. Luxury	
Piuma Feather	36MEPCN 100x50									1,15/1,40
Fodera Cover	C6M...									1,15/1,40

m³ 0,20 - kg. 5,3

Cuscini schienale

Back cushions



Descrizione Description	Codice Code	Lato Side	Tessuti - Fabrics				Pelle - Pelle			Tessuto cliente L./H. C.O.M. fabric L./H.
			Cat. B	Cat. C/D	Cat. Must	Cat. K	Cat. E	Cat. Plus	Cat. Luxury	
Piuma Feather	36MEPCN 110x50									1,25/1,40
Fodera Cover	C6M...									1,25/1,40

m³ 0,20 - kg. 5,8

Attenzione i prezzi sono riferiti solo alle scocche. Prezzi cuscini schienali da calcolare a parte (pag. 362 - 363)

Attention, the prices refer only to the sofas. Back cushions prices to be calculated separatel (page 362 - 363)

T-Time

Cuscini schienale

Back cushions



Descrizione Description	Codice Code	Lato Side	Tessuti - Fabrics				Pelle - Pelle			Tessuto cliente L./H. C.O.M. fabric L./H.
			Cat. B	Cat. C/D	Cat. Must	Cat. K	Cat. E	Cat. Plus	Cat. Luxury	
Piuma Feather	36MEPCN 120x50									1,35/1,40
Fodera Cover	C6M...									1,35/1,40

m³ 0,25 - kg. 6,4

Cuscini schienale

Back cushions



Descrizione Description	Codice Code	Lato Side	Tessuti - Fabrics				Pelle - Pelle			Tessuto cliente L./H. C.O.M. fabric L./H.
			Cat. B	Cat. C/D	Cat. Must	Cat. K	Cat. E	Cat. Plus	Cat. Luxury	
Piuma Feather	36MEPCN 58x58									0,70/1,40
Fodera Cover	C6M...									0,70/1,40

m³ 0,12 - kg. 2,9

Esempi di composizioni 1

Examples of arrangements 1

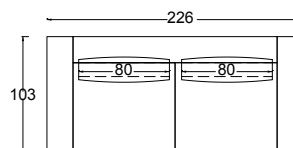

Descrizione Description	Codice Code	Lato Side	Tessuti - Fabrics				Pelle - Pelle			Tessuto cliente L./H. C.O.M. fabric L./H.
			Cat. B	Cat. C/D	Cat. Must	Cat. K	Cat. E	Cat. Plus	Cat. Luxury	
Espanso Foam	COMP. 1									10,00/1,40
Piuma Feather	COMP. 1									10,00/1,40

Codici elementi composizione

Codes of composition elements

Espanso Foam 36MCE1N 226 (x1) + 36MEPCN 80x50 (x2)

Piuma Feather 36MCP1N 226 (x1) + 36MEPCN 80x50 (x2)

Esempi di composizioni 2

Examples of arrangements 2

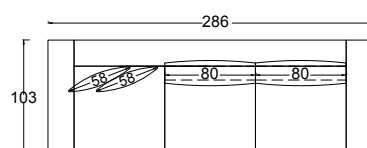

Descrizione Description	Codice Code	Lato Side	Tessuti - Fabrics				Pelle - Pelle			Tessuto cliente L./H. C.O.M. fabric L./H.
			Cat. B	Cat. C/D	Cat. Must	Cat. K	Cat. E	Cat. Plus	Cat. Luxury	
Espanso Foam	COMP. 2									13,20/1,40
Piuma Feather	COMP. 2									13,20/1,40

Codici elementi composizione

Codes of composition elements

Espanso Foam 36MCE1N 2863C (x1) + 36MEPCN 80x50 (x2) + 36MEPCN 58x58 (x2)

Piuma Feather 36MCP1N 2863C (x1) + 36MEPCN 80x50 (x2) + 36MEPCN 58x58 (x2)

Esempi di composizioni 3

Examples of arrangements 3

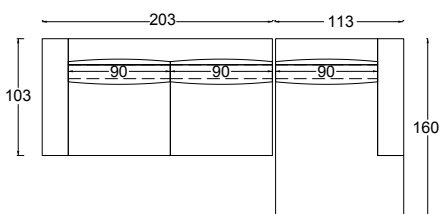

Descrizione Description	Codice Code	Lato Side	Tessuti - Fabrics				Pelle - Pelle			Tessuto cliente L./H. C.O.M. fabric L./H.
			Cat. B	Cat. C/D	Cat. Must	Cat. K	Cat. E	Cat. Plus	Cat. Luxury	
Espanso Foam	COMP. 3	SX / LH DX / RH								15,75/1,40
Piuma Feather	COMP. 3	SX / LH DX / RH								15,75/1,40

Codici elementi composizione

Codes of composition elements

Espanso Foam 36MCE2S 203 (x1) + 36MCE5R 133x160 (x1) + 36EPCN 90x50 (x3)

Piuma Feather 36MCP2S 203 (x1) + 36MCP5R 133x160 (x1) + 36EPCN 90x50 (x3)

Esempi di composizioni 4

Examples of arrangements 4

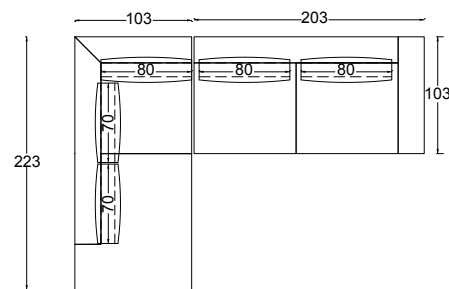

Descrizione Description	Codice Code	Lato Side	Tessuti - Fabrics				Pelle - Pelle			Tessuto cliente L./H. C.O.M. fabric L./H.
			Cat. B	Cat. C/D	Cat. Must	Cat. K	Cat. E	Cat. Plus	Cat. Luxury	
Espano Foam	COMP. 4	SX / LH DX / RH								18,55/1,40
Piuma Feather	COMP. 4	SX / LH DX / RH								18,55/1,40

Codici elementi composizione

Codes of composition elements

Espano Foam 36MCE4S 103x223 (x1) + 36MCE2R 203 (x1) + 36MEPCN 80x50 (x3) + 36MEPCN 70x50 (x2)

Piuma Feather 36MCP4S 103x223 (x1) + 36MCP2R 203 (x1) + 36MEPCN 80x50 (x3) + 36MEPCN 70x50 (x2)

Esempi di composizioni 5

Examples of arrangements 5

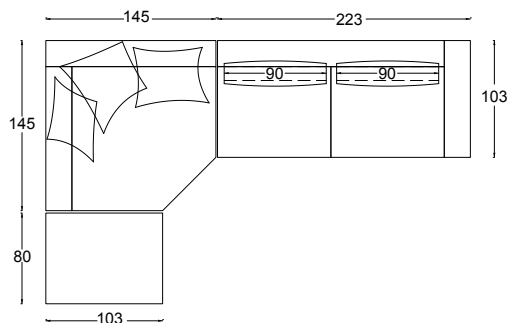

Descrizione Description	Codice Code	Lato Side	Tessuti - Fabrics				Pelle - Pelle			Tessuto cliente L./H. C.O.M. fabric L./H.
			Cat. B	Cat. C/D	Cat. Must	Cat. K	Cat. E	Cat. Plus	Cat. Luxury	
Espano Foam	COMP. 5	SX / LH DX / RH								19,35/1,40
Piuma Feather	COMP. 5	SX / LH DX / RH								19,35/1,40

Codici elementi composizione

Codes of composition elements

Espano Foam 36MCE8N 103x80 (x1) + 36MCE4R 145 (x1) + 36MCE2R 223 (x1) + 36MEPCN 90x50 (x2) + 36MEPCN 58x58 (x3)

Piuma Feather 36MCP8N 103x80 (x1) + 36MCP4R 145 (x1) + 36MCP2R 223 (x1) + 36MEPCN 90x50 (x2) + 36MEPCN 58x58 (x3)

Esempi di composizioni 6

Examples of arrangements 6

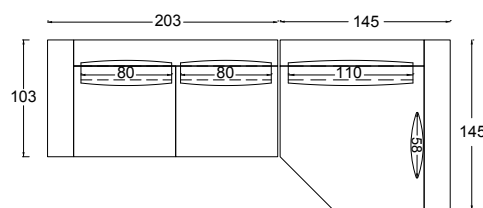

Descrizione Description	Codice Code	Lato Side	Tessuti - Fabrics				Pelle - Pelle			Tessuto cliente L./H. C.O.M. fabric L./H.
			Cat. B	Cat. C/D	Cat. Must	Cat. K	Cat. E	Cat. Plus	Cat. Luxury	
Espano Foam	COMP. 6	SX / LH DX / RH								15,85/1,40
Piuma Feather	COMP. 6	SX / LH DX / RH								15,85/1,40

Codici elementi composizione

Codes of composition elements

Espano Foam 36MCE2R 203 (x1) + 36MCE4R 145 (x1) + 36MEPCN 80x50 (x2) + 36NEECN 110x50 (x1) + 36MEPCN 58x58 (x1)

Piuma Feather 36MCP2R 203 (x1) + 36MCP4R 145 (x1) + 36MEPCN 80x50 (x2) + 36NEECN 110x50 (x1) + 36MEPCN 58x58 (x1)

