



### DOGHE SLATS

Le doghe utilizzate da Twils sono ottenute sovrapponendo 7 strati di legno di faggio di primissima qualità, che vengono incollati, pressati e termoformati a 130°C.

The slats used by Twils are made by overlaying 7 layers of prime quality beech wood, which are glued together, pressed and heat formed at 130°C.



### MOVIMENTI MOVEMENTS

Le reti con movimento alzatesta e alzapiedi manuale o motorizzato, si muovono in modo sincronizzato per il controllo totale delle zone di appoggio.

Bases with manual or motorized head and foot end lift have synchronised movement to give total control of the firmness areas.



### REGOLATORI DI PESO WEIGHT REGULATORS

Nella zona lombo-sacrale sono presenti 5 listelli doppi collegati da appositi regolatori di rigidità, adattabili con il semplice scorrimento verso l'esterno.

There are 5 double slats in the lumbar region, connected by special firmness regulators that adapt by simply sliding outwards.



### SICUREZZA SAFETY

Aggancio sicuro e pratico dei pistoni a gas nel meccanismo: praticità di montaggio, movimenti fluenti, bordi arrotondati per una sicurezza garantita.

Safe, practical engagement of the mechanism gas pistons: practical to fit, fluid movements, and rounded edges for guaranteed safety.

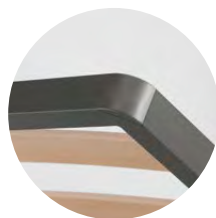

### PROFILO PROFILE

Gli angoli sono squadrate, con una resa estetica elegante e una funzione pratica di totale riempimento del letto.

The corners are square, creating elegant aesthetics and the practical function of fully containing the bed.



### SUPPORTI ANATOMICI ANATOMICAL SUPPORTS

I supporti anatomici, oltre a sostenere i listelli consentono la massima libertà di movimento rendendo la rete perfettamente adattabile a qualsiasi peso corporeo.

The anatomical supports also hold the slats to give maximum freedom of movement and make the base perfectly adaptable to any body weight.



### PISTONI RETE BOX

PISTONS ON BED BASES WITH CONTAINER

Pesi consigliati di materasso per il corretto funzionamento del sistema Box.

Recommended mattress weights to ensure the storage bases work correctly.

Dimensioni rete / materasso Bed base / mattress size	Potenza Pistoni (N) Power Pistons (N)	Codice Pistone Code Piston	Prezzo Price	Peso Materasso Cons. Rec. Mattress Weight
80	600N cad.	FERPIS00080		15Kg - 25Kg
90	600N cad.	FERPIS00080		15Kg - 25Kg
100	800N cad.	FERPIS00120		25Kg - 35Kg
120	800N cad.	FERPIS00120		25Kg - 35Kg
140	1100N cad.	FERPIS00160		30Kg - 45Kg
160	1100N cad.	FERPIS00160		30Kg - 45Kg
170	1350N cad.	FERPIS00180		40Kg - 60Kg
180	1350N cad.	FERPIS00180		40Kg - 60Kg
200	1430N cad.	FERPIS00200		45Kg - 65Kg

### PIEDI CENTRALI PER RETE IN APPOGGIO CENTRAL FEET FOR BED BASE

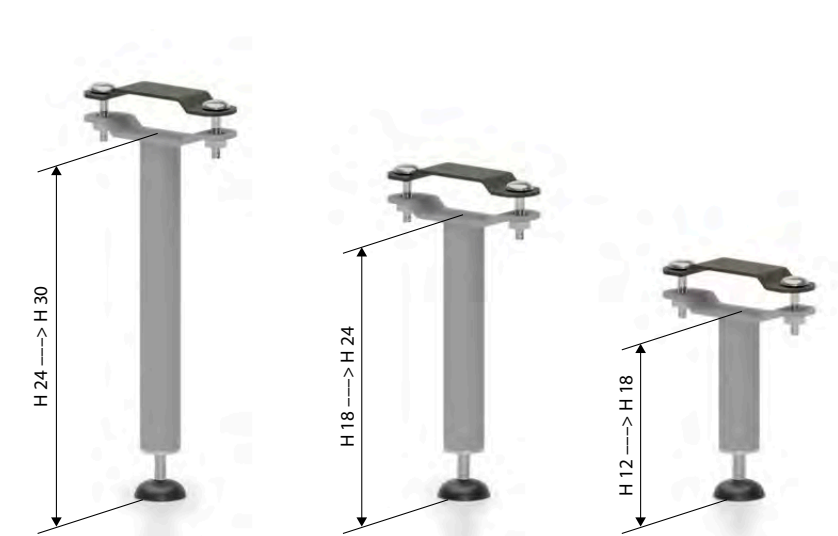

Codice Code	H.L.P.	Prezzo Price	m <sup>2</sup>	kg
PIEREG1218	H12<>H18		0,01	0,3
PIEREG1824	H18<>H24		0,01	0,5
PIEREG2430	H24<>H30		0,01	0,7

### KIT STAFFA HERCULES "HERCULES" BRACKET

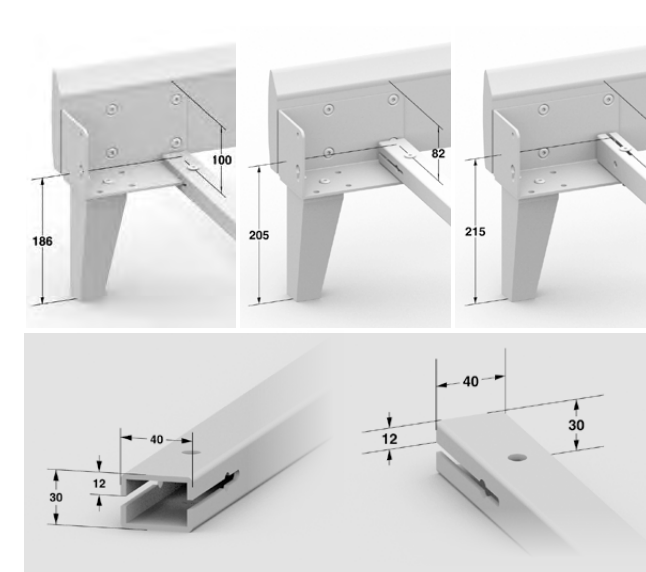

Codice Code	H.L.P.	Prezzo PZ 2 Price 2 pcs	m <sup>2</sup>	kg
STCGE3140	140		0,182	18,03
STCGE3153	153		0,182	20,03
STCGE3160	160		0,182	20,03
STCGE3170	170		0,182	22
STCGE3180	180		0,182	24,03
STCGE3193	193		0,182	27,63
STCGE3200	200		0,182	27,63

### TELAIO SUPPORTO RETE METAL SUPPORT FRAME FOR BED BASE

Profilo squadrate 40x30 prodotto sempre in versione sdoppiata.  
40X30 mm square section steel frame, always realised into two pieces.

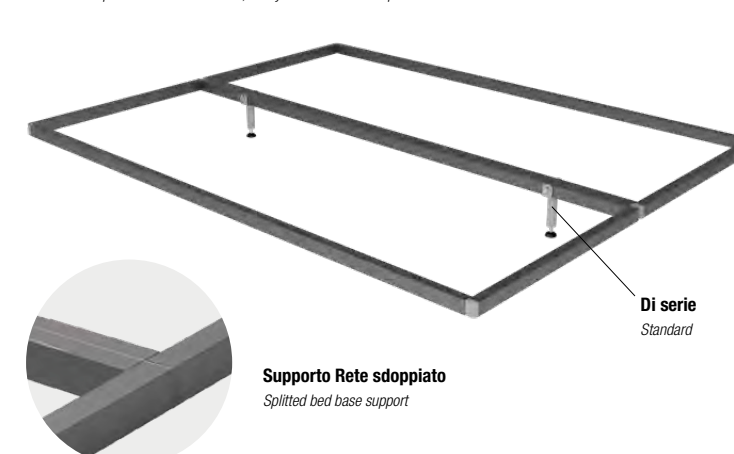

Struttura legno Wood structure	Codice Code	200 5S	210 7S	m <sup>2</sup>	kg
200	STAGET20.			0,07	8
180	STAGET18.			0,07	8
170	STAGET17.			0,07	8
160	STAGET16.			0,07	8

# Twils® Rete

box spring H8



**Concepito per rendere ancora più confortevole il letto, donando una ineguagliabile sensazione di leggerezza.**

**Versione anatomica (molle insacchettate).**

**Il piano d'appoggio è realizzato in multistrato da 30mm, forato per consentire l'areazione; l'espanso è in Aquatech con densità 40. Una base ideale per il riposo, un sistema ideato grazie all'esperienza Twils riguardo alla cultura del dormire bene.**

*Designed to make your bed even more comfortable and provide an unrivalled sensation of buoyancy. Anatomical version (pocketed springs).*

*Platform base in 30 mm plywood, perforated to allow air to circulate. The ideal base for a good night's sleep and a system that draws on years of Twils experience in the world of beds.*

Sistema molle insacchettate Pocket spring system	Codice Code	200	m <sup>3</sup>	kg
<b>200</b>	RETEBT205		1,28	72
<b>180</b>	RETEBT185		1,10	70
<b>170</b>	-		-	-
<b>160</b>	RETEBT165		1,04	64
<b>140</b>	-		-	-
<b>100</b>	RETEBT105		0,64	36
<b>90</b>	RETEBT095		0,52	36
<b>80</b>	RETEBT085		0,52	33

**Maggiorazioni** - Extra charge

**190**

**210**

# Twils® Rete

box spring H22

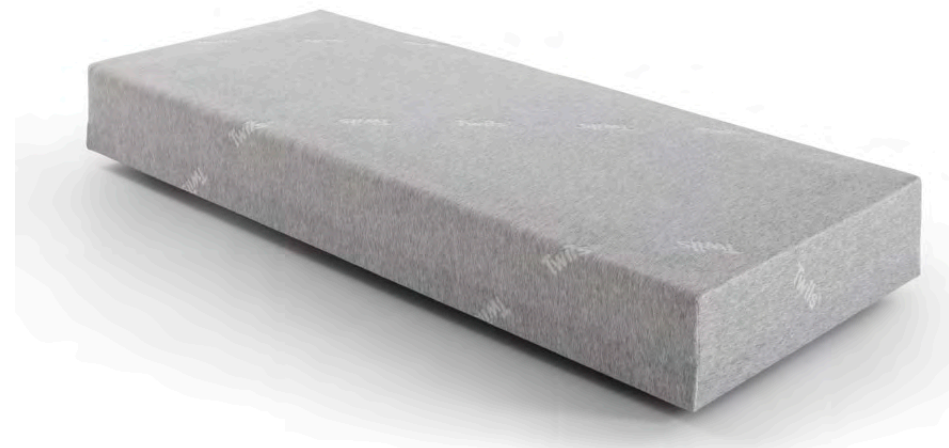

**Concepito per rendere ancora più confortevole il letto, donando una ineguagliabile sensazione di leggerezza. Versione anatomica (molle insacchettate).**

**Il piano d'appoggio è realizzato in multistrato da 30mm, forato per consentire l'areazione;**

**l'espanso è in Aquatech con densità 40. Una base ideale per il riposo, un sistema ideato grazie all'esperienza Twils riguardo alla cultura del dormire bene.**

*Designed to make your bed even more comfortable and provide an unrivalled sensation of buoyancy. Anatomical version (pocketed springs).*

*Platform base in 30 mm plywood, perforated to allow air to circulate. The ideal base for a good night's sleep and a system that draws on years of Twils experience in the world of beds.*

Sistema molle insacchettate Pocket spring system	Codice Code	200	m <sup>3</sup>	kg
<b>200</b>	RETEBT205		1,28	72
<b>180</b>	RETEBT185		1,10	70
<b>170</b>	-		-	-
<b>160</b>	RETEBT165		1,04	64
<b>140</b>	-		-	-
<b>120</b>	RETEBT125		0,91	37
<b>100</b>	RETEBT105		0,64	36
<b>90</b>	RETEBT095		0,52	36
<b>80</b>	RETEBT085		0,52	33

**Maggiorazioni** - Extra charge

**190**

**210**

# Twils® Ortopedic

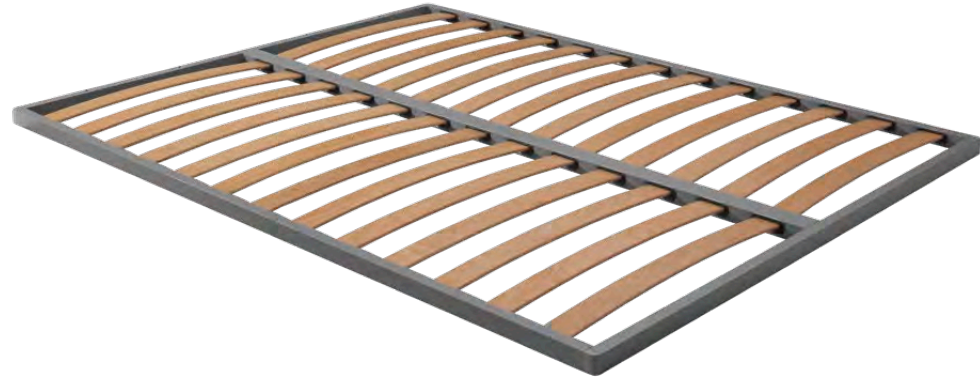

**Doppio profilo centrale**  
Central longitudinal rail



**Angoli squadrati**  
Squared corners

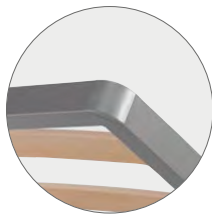

**Rete Piana a Doghe con Stuttura Metallo.**

**Profilo squadrato 40x30 mm in acciaio**  
**26 listelli in faggio sagomato a vapore da 68x8 mm,**  
**Versioni matrimoniali doppio profilo centrale 30x40mm.**

*Slatted bed base with metal frame.*

- 40x30 mm square section steel frame
- 26 steam-bent beech slats 68x8 mm
- Double beds with 30x40 mm central longitudinal rail.

Struttura Structure	Codice Code	190 3	200 5	210 7	m <sup>3</sup>	kg
<b>200</b>	RETE0520.				0,20	28
<b>193</b>	RETE0519K.				0,20	28
<b>180</b>	RETE0518.				0,20	28
<b>170</b>	RETE0517.				0,17	25
<b>160</b>	RETE0516.				0,17	25
<b>153</b>	RETE0515Q.				0,20	28
<b>140</b>	RETE0514.				0,14	22
<b>120</b>	RETE0512.				0,12	18
<b>100</b>	RETE0510.				0,10	16
<b>90</b>	RETE0509.				0,09	14
<b>80</b>	RETE0508.				0,08	13

Lavorazioni su misura - Custom made

**Fuori misura**  
Special size

**Per rete sdoppiata con struttura metallica**  
For two-piece bed base with metal structure

# Twils® Ortopedic Plus

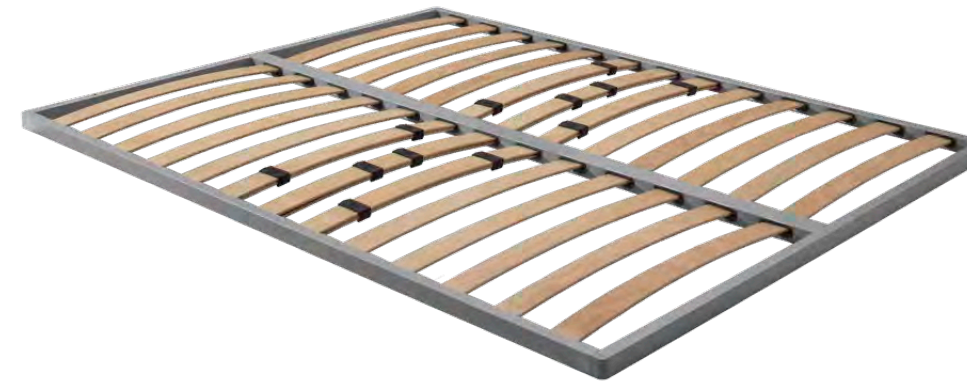

**Regolatori di peso**  
Weight regulators



**Doppio profilo centrale**  
Central longitudinal rail



**Angoli squadrati**  
Squared corners

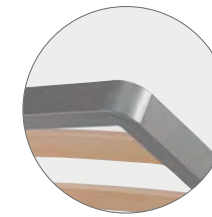

**Rete Piana a Doghe con Stuttura Metallo.**

**Profilo squadrato 40x30 mm in acciaio**  
**26 listelli in faggio sagomato a vapore da 68x8 mm**  
**Versioni matrimoniali doppio profilo 30x40mm**  
**6 doppi listelli con regolatori di peso nella parte centrale**

*Slatted bed base with metal frame.*

- 40x30 mm square section steel frame
- 26 steam-bent beech slats 68x8 mm
- Double beds with 30x40 mm central longitudinal rail
- 6 double slats with weight regulators in the central part

Struttura Structure	Codice Code	190 3	200 5	210 7	m <sup>3</sup>	kg
<b>200</b>	RETE0520. + 2 RETKPL100				0,20	28
<b>193</b>	RETE0519K. + 2 RETKPL19K				0,20	28
<b>180</b>	RETE0518. + 2 RETKPL090				0,20	28
<b>170</b>	RETE0517. + 2 RETKPL085				0,17	25
<b>160</b>	RETE0516. + 2 RETKPL080				0,17	25
<b>153</b>	RETE0515Q. + 2 RETKPL15Q				0,20	28
<b>140</b>	RETE0514. + 2 RETKPL070				0,14	22
<b>120</b>	-				-	-
<b>100</b>	RETE0510. + 1 RETKPL100				0,10	16
<b>90</b>	RETE0509. + 1 RETKPL090				0,09	14
<b>80</b>	RETE0508. + 1 RETKPL080				0,08	13

Lavorazioni su misura - Custom made

**Fuori misura**  
Special size

**Per rete sdoppiata con struttura metallica**  
For two-piece bed base with metal structure



# Twils® One



**Doga unica**  
Single slat



**Angoli squadrati**  
Squared corners

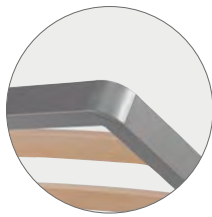

#### Rete Piana a Doghe con Stuttura Metallo.

**Profilo squadrato 40x30 mm in acciaio**  
**13 listelli in faggio sagomato a vapore da 68x8 mm**  
**Disponibile solo versione matrimoniale**

*Slatted bed base with metal frame.*

- 40x30 mm square section steel frame  
- 13 steam-bent beech slats 68x8 mm  
- Available in the double bed version only

Struttura Structure	Codice Code	190 3	200 5	210 7	m <sup>3</sup>	kg
200	-				-	-
180	RETE0618.				0,26	30
170	-				-	-
160	RETE0616.				0,24	27
140	-				-	-
120	-				-	-
100	-				-	-
90	-				-	-
80	-				-	-

# Twils® Comfort



**Regolatori di peso**  
Weight regulators



**Supporti anatomici**  
Anatomical supports

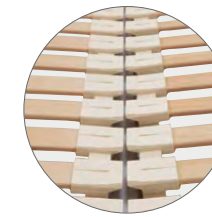

**Angoli stondati**  
Rounded corners

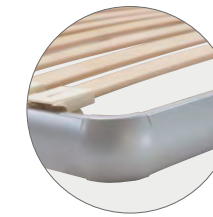

#### Rete Piana a Doghe con Stuttura Metallo con supporti anatomici e regolatori di peso.

**Profilo stondato 51x39 mm in acciaio**  
**Versioni matrimoniali doppio profilo 30x40mm**  
**56 listelli in faggio sagomati a vapore da 38x8 mm montati su supporti anatomici**  
**12 doppi listelli con regolatori di peso nella parte centrale**

*Slatted bed base with metal frame, anatomical supports and weight regulators.*

- 51x39 mm rounded section steel frame  
- Double beds with 30x40 mm longitudinal rail  
- 56 steam-bent beech slats 38x8 mm mounted on anatomical supports  
- 12 double slats with weight regulators in the central part

Struttura Structure	Codice Code	190 3	200 5	210 7	m <sup>3</sup>	kg
200	-				-	-
180	RETE1118.				0,18	38
170	-				-	-
160	RETE1116.				0,16	33
140	-				-	-
120	RETE1112.				0,12	23
100	-				-	-
90	RETE1109.				0,09	18
80	-				-	-

Lavorazioni su misura - Custom made

**Fuori misura**  
Special size

**Per rete sdoppiata con struttura metallica**  
For two-piece bed base with metal structure

# Twils® Wood



**Doppio profilo centrale**  
Central longitudinal rail



**Angoli squadrati**  
Squared corners



**Rete Piana a Doghe con Struttura Legno.**

**Profilo 60x25 mm in multistrato di faggio**  
**26 listelli in faggio sagomato a vapore da 68x8 mm.**

*Slatted bed base with wooden frame.*

- 60x25 mm laminated beech frame  
- 26 steam-bent beech slats 68x8 mm

Struttura legno <i>Wood structure</i>	Codice <i>Code</i>	190 3	200 5	210 7	m <sup>3</sup>	kg
<b>200</b>	-				-	-
<b>180</b>	RETE2018.				0,26	32
<b>170</b>	RETE2017.				0,25	30
<b>160</b>	RETE2016.				0,22	30
<b>140</b>	RETE2014.				0,16	20
<b>120</b>	RETE2012.				0,15	18
<b>100</b>	RETE2010.				0,12	17
<b>90</b>	RETE2009.				0,11	16
<b>80</b>	RETE2008.				0,10	15

Lavorazioni su misura - Custom made

**Fuori misura**  
*Special size*

# Twils® Wood Plus



**Regolatori di peso**  
Weight regulators



**Doppio profilo centrale**  
Central longitudinal rail



**Angoli squadrati**  
Squared corners



**Rete Piana a Doghe con Struttura Legno.**

**Profilo 60x25 mm in multistrato di faggio**  
**26 listelli in faggio sagomato a vapore da 68x8 mm.**  
**6 doppi listelli con regolatori di peso nella parte centrale**

*Slatted bed base with wooden frame.*

- 60x25 mm laminated beech frame  
- 26 steam-bent beech slats 68x8 mm  
- 6 double slats with weight regulators in the central part

Struttura legno <i>Wood structure</i>	Codice <i>Code</i>	190 3	200 5	210 7	m <sup>3</sup>	kg
<b>200</b>	-				-	-
<b>180</b>	RETE20185 + 2 RETKPL090				0,26	32
<b>170</b>	RETE20175 + 2 RETKPL085				0,25	30
<b>160</b>	RETE20165 + 2 RETKPL080				0,22	30
<b>140</b>	RETE20145 + 2 RETKPL070				0,16	20
<b>120</b>	RETE20125 + 1 RETKPL120				0,15	18
<b>100</b>	RETE20105 + 1 RETKPL100				0,12	17
<b>90</b>	RETE20095 + 1 RETKPL090				0,11	16
<b>80</b>	RETE20085 + 1 RETKPL080				0,10	15

Lavorazioni su misura - Custom made

**Fuori misura**  
*Special size*

# Twils® Ergonomic

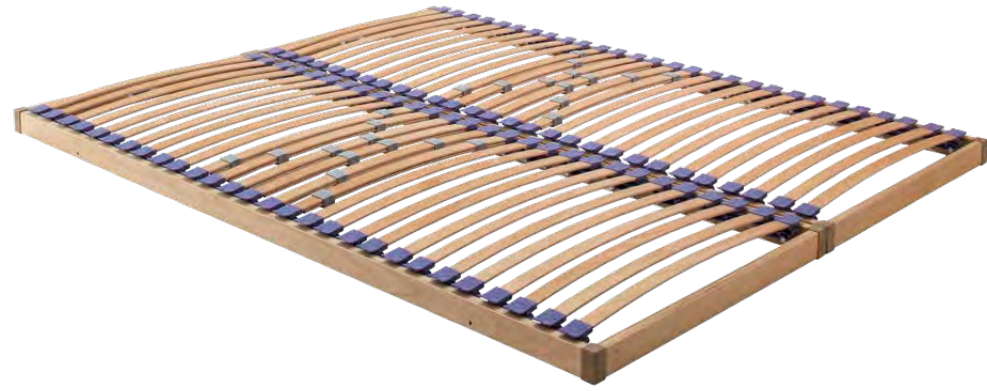

**N.B: nella versione matrimoniale le reti in legno sono sempre 2 singole.**

*N.B: in the double bed version bed bases with wood structure are always divided into two pieces.*

**Supporti anatomici**  
*Anatomical supports*



**Supporti anatomici**  
*Anatomical supports*



**Regolatori di peso**  
*Weight regulators*



**Angoli squadrati**  
*Squared corners*



**Rete Piana a Doghe con Struttura Legno con supporti anatomici e regolatori di peso.**

**Profilo 60x25 mm in multistrati di faggio**

**Versioni matrimoniali doppio profilo 30x40mm**

**56 listelli in faggio sagomati a vapore da 38x8 mm montati su supporti anatomici**

**12 doppi listelli con regolatori di peso nella parte centrale**

*Slatted bed base with wooden frame, anatomical supports and weight regulators.*

*- 60x25 mm laminated beech frame*

*- Double beds with 30x40 mm longitudinal rail*

*- 56 steam-bent beech slats 38x8 mm mounted on anatomical supports*

*- 12 double slats with weight adjusters in the central part*

Struttura legno <i>Wood structure</i>	Codice <i>Code</i>	190 3	200 5	210 7	m <sup>3</sup>	kg
<b>200</b>	-				-	-
<b>180</b>	RETE2118.				0,26	28
<b>170</b>	RETE2117.				0,25	25
<b>160</b>	RETE2116.				0,23	25
<b>140</b>	RETE2114.				0,17	20
<b>120</b>	RETE2112.				0,15	17
<b>100</b>	RETE2110.				0,12	16
<b>90</b>	RETE2109.				0,11	14
<b>80</b>	RETE2108.				0,10	13

**Lavorazioni su misura - Custom made**

**Fuori misura**

*Special size*

# Twils® Ergo Plus



**N.B: nella versione matrimoniale le reti in legno sono sempre 2 singole.**

*N.B: in the double bed version bed bases with wood structure are always divided into two pieces.*

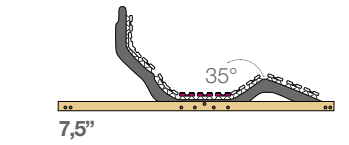
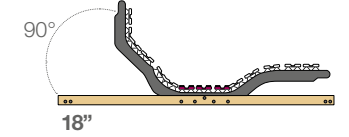
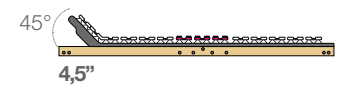

**Telecomando**  
*Remote controller*



**Motore compatto**  
*Compact motor*



**Regolatori di peso**  
*Weight regulators*



**Supporti anatomici**  
*Anatomical supports*



**Angoli squadrati**  
*Squared corners*



**Rete Alzatesta/Piedi motorizzata Struttura Legno.**

**Profilo 70x25 mm in multistrato di faggio**

**56 listelli in multistrato di faggio sagomate a vapore da 38x8 mm**

**12 doppi listelli con regolatori di peso nella parte centrale**

**Motore a bassa tensione che consente di regolare a piacere l'inclinazione della testiera e della pediera**

**Movimenti separati per reti matrimoniali**

**Priva di leveraggi a vista**

*Bed base with electrically adjustable head/foot sections and wooden frame.*

*- 70x25 mm laminated beech frame*

*- 56 steam-bent laminated beech slats 38x8 mm*

*- 12 double slats with weight adjusters in the central part*

*- Fitted with a low-voltage motor which allows you to adjust the inclination of the headboard and footboard as you wish*

*- Separate movements for double bed bases*

*- Free of visible lever mechanisms*

Struttura legno <i>Wood structure</i>	Codice <i>Code</i>	190 3	200 5	210 7	m <sup>3</sup>	kg
<b>200</b>	RETE4120.				0,50	45
<b>180</b>	RETE4118.				0,29	37
<b>170</b>	-				-	-
<b>160</b>	RETE4116.				0,24	29
<b>140</b>	-				-	-
<b>120</b>	-				-	-
<b>100</b>	RETE4110.				0,21	23
<b>90</b>	RETE4109.				0,12	19
<b>80</b>	RETE4108.				0,10	15

**Lavorazioni su misura - Custom made**

**Fuori misura**

*Special size*

**Optional - Optional**



**Radiocomando**  
*Wireless remote controller*

Cad.  
Pcs.

**Per le misure da 140 a 200 sono necessari due radiocomandi per muovere le reti in modo indipendente.**  
*For sizes from 140 to 200, two wireless remote controls are required to move the two bed bases independently.*



**Cavetto doppio, per comandare due motori con una pulsantiera.**  
*Double cable, to control two motors with a push-button panel*



# Twils® Move



**N.B: nella versione matrimoniale le reti in legno sono sempre 2 singole.**  
N.B: in the double bed version bed bases with wood structure are always divided into two pieces.

# Twils® Coprirete

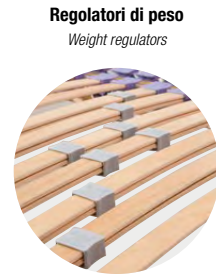
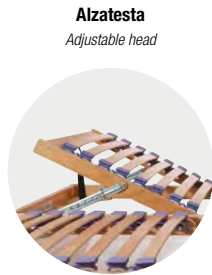

**Rete Alzatesta/Piedi a Doghe con Struttura Legno con supporti anatomici.**

Slatted bed base with adjustable head/foot sections and wooden frame with anatomical supports.

**Profilo 60x25 mm in multistrati di faggio**  
**Versioni matrimoniali doppio profilo 30x40mm**  
**56 listelli in faggio sagomati a vapore da 38x8 mm montati su supporti anatomici**  
**12 doppi listelli con regolatori di peso nella parte centrale**  
**Testiera e pediera sono regolabili in 15 posizioni diverse**

- 60x25 mm laminated beech frame
- Double beds with 30x40 mm longitudinal rail
- 56 steam-bent beech slats 38x8 mm mounted on anatomical supports
- 12 double slats with weight adjusters in the central part
- Headboard and footboard can be adjusted to 15 different positions

**Vestibilità semplice e precisa**  
**Tessuto sanforizzato**  
**Coprirete per rete box**  
**Coprirete per rete piana**

- Easy and precise fit
- Sanforized fabric
- Bed base cover for storage bed
- Bed base cover

Struttura legno Wood structure	Codice Code	190 3	200 5	210 7	m³	kg
<b>200</b>	-				-	-
<b>180</b>	RETE3118.				0,29	53
<b>170</b>	RETE3117.				0,27	47
<b>160</b>	RETE3116.				0,27	47
<b>140</b>	-				-	-
<b>120</b>	RETE3112.				0,12	27
<b>100</b>	-				-	-
<b>90</b>	RETE3109.				0,12	27
<b>80</b>	RETE3108.				0,11	24

Lavorazioni su misura - Custom made

**Fuori misura**  
Special size



Coprirete per rete box Bed base cover for storage	Codice Code	190 3	200 5	210 7	m³	kg
<b>200</b>	57520.C00				0,00	1
<b>180</b>	57518.C00				0,00	1
<b>170</b>	57517.C00				0,00	1
<b>160</b>	57516.C00				0,00	2
<b>140</b>	57514.C00				0,00	1
<b>120</b>	57512.C00				0,00	1
<b>100</b>	57510.C00				0,00	1
<b>90</b>	57509.C00				0,00	1
<b>80</b>	57508.C00				0,00	1



Coprirete per rete piana Bed base cover	Codice Code	190 3	200 5	210 7	m³	kg
<b>200</b>	57520.C24				0,00	2
<b>180</b>	57518.C24				0,00	2
<b>170</b>	57517.C24				0,00	2
<b>160</b>	57516.C24				0,00	2
<b>140</b>	57514.C24				0,00	2
<b>120</b>	57512.C24				0,00	2
<b>100</b>	57510.C24				0,00	2
<b>90</b>	57509.C24				0,00	2
<b>80</b>	57508.C24				0,00	2