

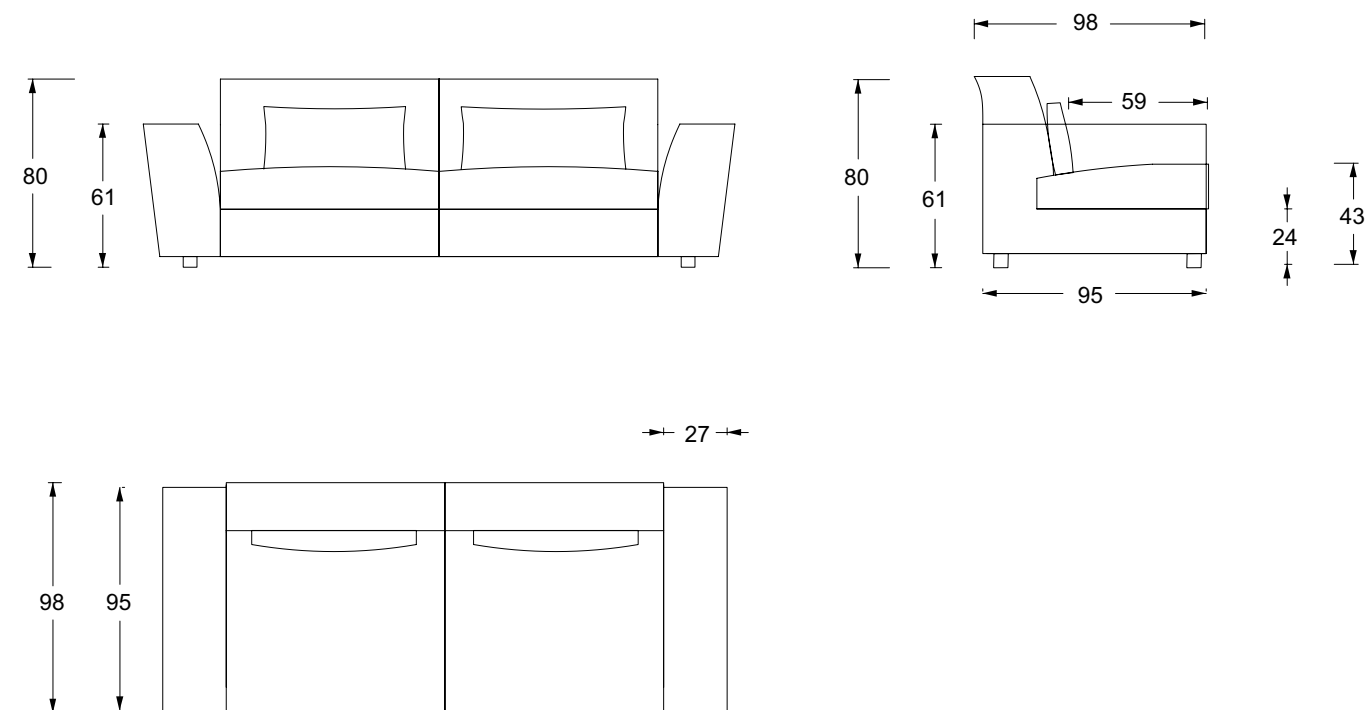

file 3D



Completamente sfoderabile

- ① poliuretano D35 IM
- ② memory foam D40
- ③ piuma d'oca
- ④ poliuretano D40 IPP
- ⑤ poliuretano D21 IM
- ⑥ fibra di poliestere da 300 gr accoppiata
- ⑦ poliuretano D25 IM
- ⑧ vellutino trapuntato da 60 gr
- ⑨ multistrato e massello di pioppo e abete
- ⑩ fibra di legno
- ⑪ cinghie elastiche da 6 e 8 cm incrociate

piedi ABS nero H. 4 cm

Completely removable cover

- ① polyurethane D35 IM
- ② memory foam D40
- ③ goose feather
- ④ polyurethane D40 IPP
- ⑤ polyurethane D21 IM
- ⑥ velcover on a resin-coated backing 300 gr
- ⑦ polyurethane D25 IM
- ⑧ velcover 60 gr
- ⑨ plywood and solid poplar and fir
- ⑩ wood fibre
- ⑪ elastic belts 6/8 cm cross weft

feet ABS black H. 4 cm

Divani

Sofas

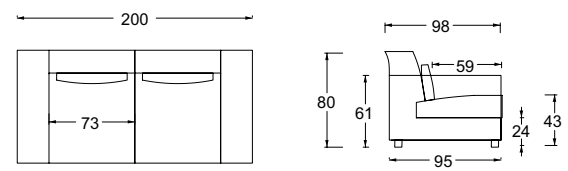

Descrizione Description	Codice Code	Lato Side	Tessuti - Fabrics				Pelle - Pelle			Tessuto cliente L./H. C.O.M. fabric L./H.
			Cat. B	Cat. C/D	Cat. Must	Cat. K	Cat. E	Cat. Plus	Cat. Luxury	
Piuma Feather	35GCP1N 200									8,40/1,40
Fodera Cover	C5GCP1N 200									8,40/1,40

m³ 1,70 - kg. 73

Divani

Sofas

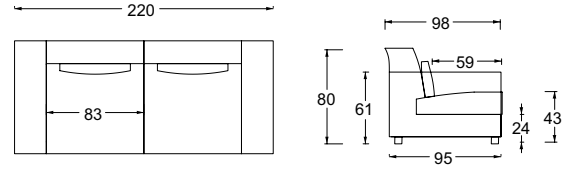

Descrizione Description	Codice Code	Lato Side	Tessuti - Fabrics				Pelle - Pelle			Tessuto cliente L./H. C.O.M. fabric L./H.
			Cat. B	Cat. C/D	Cat. Must	Cat. K	Cat. E	Cat. Plus	Cat. Luxury	
Piuma Feather	35GCP1N 220									8,80/1,40
Fodera Cover	C5GCP1N 220									8,80/1,40

m³ 1,85 - kg. 78

Divani

Sofas

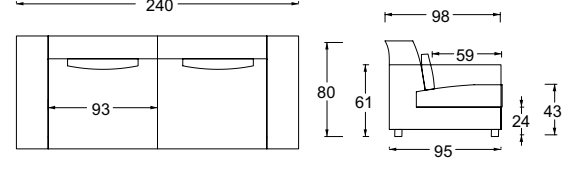

Descrizione Description	Codice Code	Lato Side	Tessuti - Fabrics				Pelle - Pelle			Tessuto cliente L./H. C.O.M. fabric L./H.
			Cat. B	Cat. C/D	Cat. Must	Cat. K	Cat. E	Cat. Plus	Cat. Luxury	
Piuma Feather	35GCP1N 240									9,25/1,40
Fodera Cover	C5GCP1N 240									9,25/1,40

m³ 2,00 - kg. 84

Divani

Sofas

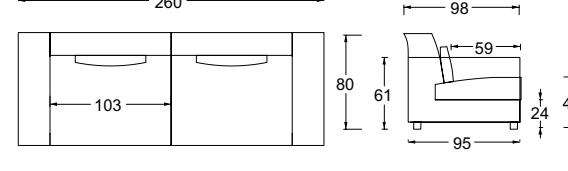

Descrizione Description	Codice Code	Lato Side	Tessuti - Fabrics				Pelle - Pelle			Tessuto cliente L./H. C.O.M. fabric L./H.
			Cat. B	Cat. C/D	Cat. Must	Cat. K	Cat. E	Cat. Plus	Cat. Luxury	
Piuma Feather	35GCP1N 260									9,80/1,40
Fodera Cover	C5GCP1N 260									9,80/1,40

m³ 2,20 - kg. 90

Laterali

Side element

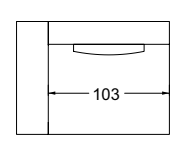

Descrizione Description	Codice Code	Lato Side	Tessuti - Fabrics				Pelle - Pelle			Tessuto cliente L./H. C.O.M. fabric L./H.
			Cat. B	Cat. C/D	Cat. Must	Cat. K	Cat. E	Cat. Plus	Cat. Luxury	
Piuma Feather	35GCP2S 130 35GCP2R 130	SX / LH DX / RH								5,40/1,40
Fodera Cover	C5GCP2S 130 C5GCP2R 130	SX / LH DX / RH								5,40/1,40

m³ 1,10 - kg. 45

Laterali

Side element

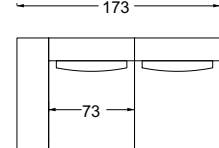

Descrizione Description	Codice Code	Lato Side	Tessuti - Fabrics				Pelle - Pelle			Tessuto cliente L./H. C.O.M. fabric L./H.
			Cat. B	Cat. C/D	Cat. Must	Cat. K	Cat. E	Cat. Plus	Cat. Luxury	
Piuma Feather	35GCP2S 173 35GCP2R 173	SX / LH DX / RH								7,60/1,40
Fodera Cover	C5GCP2S 173 C5GCP2R 173	SX / LH DX / RH								7,60/1,40

m³ 1,60 - kg. 60

Laterali

Side element

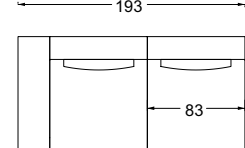

Descrizione Description	Codice Code	Lato Side	Tessuti - Fabrics				Pelle - Pelle			Tessuto cliente L./H. C.O.M. fabric L./H.
			Cat. B	Cat. C/D	Cat. Must	Cat. K	Cat. E	Cat. Plus	Cat. Luxury	
Piuma Feather	35GCP2S 193 35GCP2R 193	SX / LH DX / RH								8,25/1,40
Fodera Cover	C5GCP2S 193 C5GCP2R 193	SX / LH DX / RH								8,25/1,40

m³ 1,70 - kg. 65

Laterali

Side element

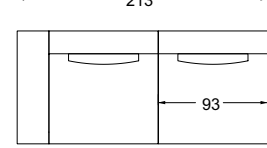

Descrizione Description	Codice Code	Lato Side	Tessuti - Fabrics				Pelle - Pelle			Tessuto cliente L./H. C.O.M. fabric L./H.
			Cat. B	Cat. C/D	Cat. Must	Cat. K	Cat. E	Cat. Plus	Cat. Luxury	
Piuma Feather	35GCP2S 213 35GCP2R 213	SX / LH DX / RH								8,40/1,40
Fodera Cover	C5GCP2S 213 C5GCP2R 213	SX / LH DX / RH								8,40/1,40

m³ 1,80 - kg. 70

Laterali

Side element

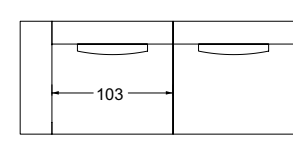

Descrizione Description	Codice Code	Lato Side	Tessuti - Fabrics				Pelle - Pelle			Tessuto cliente L./H. C.O.M. fabric L./H.
			Cat. B	Cat. C/D	Cat. Must	Cat. K	Cat. E	Cat. Plus	Cat. Luxury	
Piuma Feather	35GCP2S 233 35GCP2R 233	SX / LH DX / RH								9,05/1,40
Fodera Cover	C5GCP2S 233 C5GCP2R 233	SX / LH DX / RH								9,05/1,40

m³ 1,90 - kg. 75

Penisole

Chaise longues

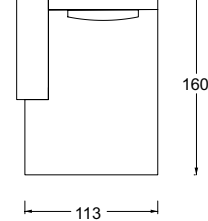

Descrizione Description	Codice Code	Lato Side	Tessuti - Fabrics				Pelle - Pelle			Tessuto cliente L./H. C.O.M. fabric L./H.
			Cat. B	Cat. C/D	Cat. Must	Cat. K	Cat. E	Cat. Plus	Cat. Luxury	
Piuma Feather	35GCP5S 120 35GCP5R 120	SX / LH DX / RH								6,75/1,40
Fodera Cover	C5GCP5S 120 C5GCP5R 120	SX / LH DX / RH								6,75/1,40

m³ 1,70 - kg. 60

Angolo Comer

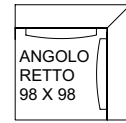

Descrizione Description	Codice Code	Lato Side	Tessuti - Fabrics				Pelle - Pelle			Tessuto cliente L./H. C.O.M. fabric L./H.
			Cat. B	Cat. C/D	Cat. Must	Cat. K	Cat. E	Cat. Plus	Cat. Luxury	
Piuma Feather	35GCP4N 098									5,65/1,40
Fodera Cover	C5GCP4N 098									5,65/1,40

m³ 0,90 - kg. 46

Pouf Footstool

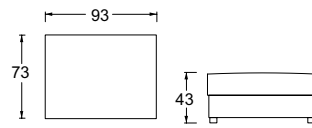

Descrizione Description	Codice Code	Lato Side	Tessuti - Fabrics				Pelle - Pelle			Tessuto cliente L./H. C.O.M. fabric L./H.
			Cat. B	Cat. C/D	Cat. Must	Cat. K	Cat. E	Cat. Plus	Cat. Luxury	
Piuma Feather	35GCP8N 073									2,90/1,40
Fodera Cover	C5GCP8N 073									2,90/1,40

m³ 0,35 - kg. 22

Pouf Footstool

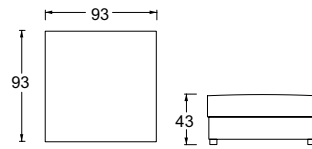

Descrizione Description	Codice Code	Lato Side	Tessuti - Fabrics				Pelle - Pelle			Tessuto cliente L./H. C.O.M. fabric L./H.
			Cat. B	Cat. C/D	Cat. Must	Cat. K	Cat. E	Cat. Plus	Cat. Luxury	
Piuma Feather	35GCP8N 093									3,45/1,40
Fodera Cover	C5GCP8N 093									3,45/1,40

m³ 0,40 - kg. 24

Esempi di composizioni 1 Examples of arrangements 1

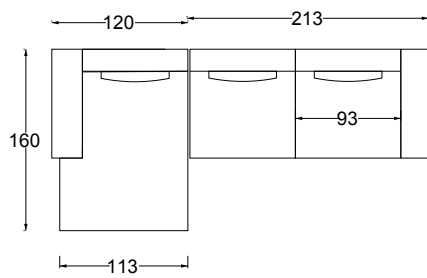

Descrizione Description	Codice Code	Lato Side	Tessuti - Fabrics				Pelle - Pelle			Tessuto cliente L./H. C.O.M. fabric L./H.
			Cat. B	Cat. C/D	Cat. Must	Cat. K	Cat. E	Cat. Plus	Cat. Luxury	
Espanso Foam	COMP. 1									15,15/1,40

Codici elementi composizione
Codes of composition elements
35GCP5 120 (x1) + 35GCP2 213 (x1)

