



cucitura pinzata
gathered stitching



cucitura ribattuta
flat-felled seams



cucitura taglio vivo (solo pelle)
raw edges stitching (leather version)

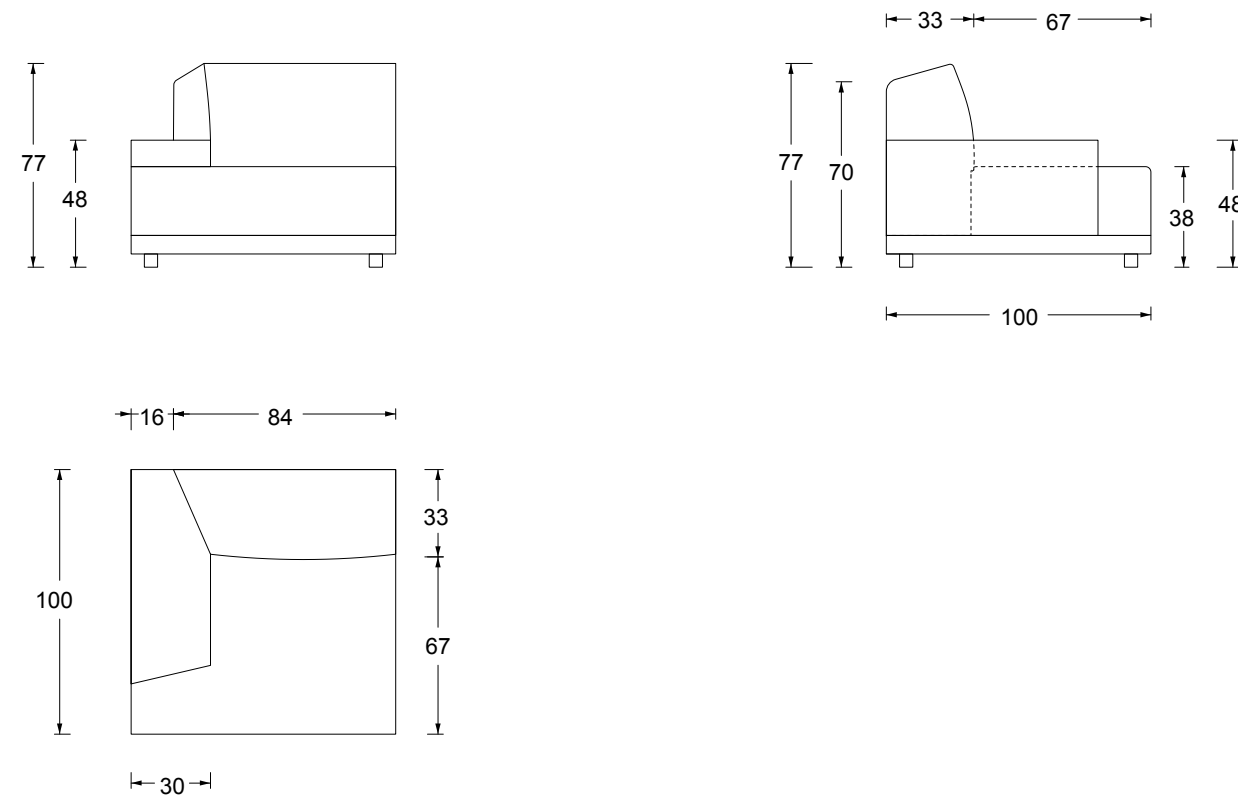

Completamente sfoderabile

- ① multistrato di legno con massello di pioppo e abete
- ② fibra di legno
- ③ poliuretano 40 IP
- ④ poliuretano PF 30 Elast
- ⑤ poliuretano 40 RC
- ⑥ poliuretano 30 P
- ⑦ viscoelastica memory 40
- ⑧ fibra poliestere 380 gr accoppiata con cotone
- ⑨ fibra poliestere 280 gr accoppiata con cotone
- ⑩ poliuretano 30 IP

piedini in ABS nero h. 4 cm

Completely removable cover

- ① plywood panels and poplar or pine solide wood
- ② wood fibre board
- ③ polyurethane foam 40IP
- ④ polyurethane foam PF30 Elast
- ⑤ polyurethane foam 40RC
- ⑥ polyurethane foam 30P
- ⑦ memory foam 40
- ⑧ 380 gr/mq polyester fibre covered with cotton fabric
- ⑨ 280 gr/mq polyester fibre covered with cotton fabric
- ⑩ polyurethane foam 30 IP

feet in black ABS h. 4 cm



file 3D

Laterali
Side element

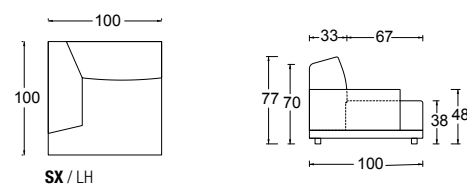

Descrizione Description	Codice Code	Lato Side	Tessuti - Fabrics				Pelle - Pelle			Tessuto cliente L./H. C.O.M. fabric L./H.
			Cat. B	Cat. C/D	Cat. Must	Cat. K	Cat. E	Cat. Plus	Cat. Luxury	
Espanso Foam	346CE2S 100	SX / LH								6,00/1,40
Fodera Cover	346CE2R 100	DX / RH								6,00/1,40

m³ 0,9 - kg. 21

Laterali
Side element

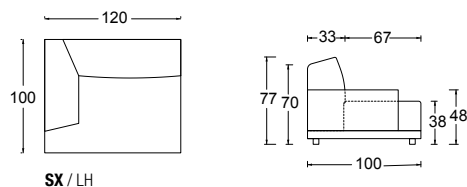

Descrizione Description	Codice Code	Lato Side	Tessuti - Fabrics				Pelle - Pelle			Tessuto cliente L./H. C.O.M. fabric L./H.
			Cat. B	Cat. C/D	Cat. Must	Cat. K	Cat. E	Cat. Plus	Cat. Luxury	
Espanso Foam	346CE2S 120	SX / LH								6,50/1,40
Fodera Cover	346CE2R 120	DX / RH								6,50/1,40

m³ 1,5 - kg. 25

Angolo
Corner

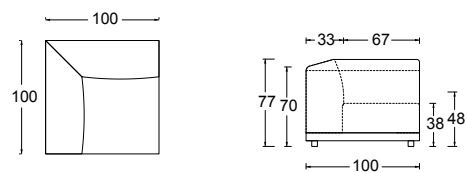

Descrizione Description	Codice Code	Lato Side	Tessuti - Fabrics				Pelle - Pelle			Tessuto cliente L./H. C.O.M. fabric L./H.
			Cat. B	Cat. C/D	Cat. Must	Cat. K	Cat. E	Cat. Plus	Cat. Luxury	
Espanso Foam	346CE4N 100									8,50/1,40
Fodera Cover										8,50/1,40

m³ 0,9 - kg. 21

Centrali
Central elements

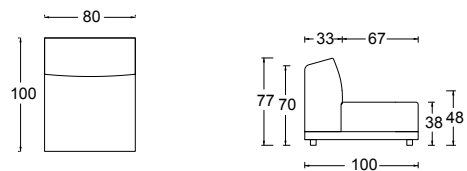

Descrizione Description	Codice Code	Lato Side	Tessuti - Fabrics				Pelle - Pelle			Tessuto cliente L./H. C.O.M. fabric L./H.
			Cat. B	Cat. C/D	Cat. Must	Cat. K	Cat. E	Cat. Plus	Cat. Luxury	
Espanso Foam	346CE3N 80									4,50/1,40
Fodera Cover										4,50/1,40

m³ 0,75 - kg. 18

Centrali
Central elements

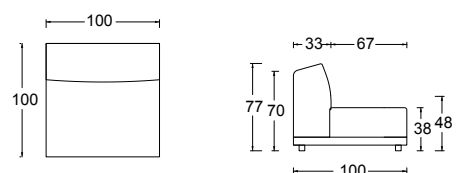

Descrizione Description	Codice Code	Lato Side	Tessuti - Fabrics				Pelle - Pelle			Tessuto cliente L./H. C.O.M. fabric L./H.
			Cat. B	Cat. C/D	Cat. Must	Cat. K	Cat. E	Cat. Plus	Cat. Luxury	
Espanso Foam	346CE3N 100									5,50/1,40
Fodera Cover										5,50/1,40

m³ 0,9 - kg. 21

Pouf
Footstool

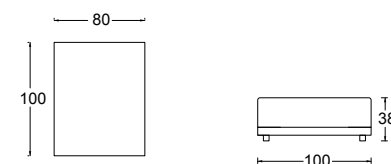

Descrizione Description	Codice Code	Lato Side	Tessuti - Fabrics				Pelle - Pelle			Tessuto cliente L./H. C.O.M. fabric L./H.
			Cat. B	Cat. C/D	Cat. Must	Cat. K	Cat. E	Cat. Plus	Cat. Luxury	
Espanso Foam	346CE8N 100x80									3,00/1,40
Fodera Cover										3,00/1,40

m³ 0,4 - kg. 13

Pouf
Footstool

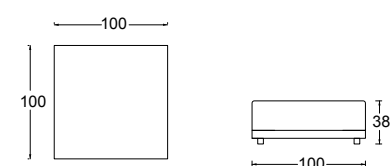

Descrizione Description	Codice Code	Lato Side	Tessuti - Fabrics				Pelle - Pelle			Tessuto cliente L./H. C.O.M. fabric L./H.
			Cat. B	Cat. C/D	Cat. Must	Cat. K	Cat. E	Cat. Plus	Cat. Luxury	
Espanso Foam	346CE8N 100x100									3,50/1,40
Fodera Cover										3,50/1,40

m³ 0,45 - kg. 19

Pouf
Footstool

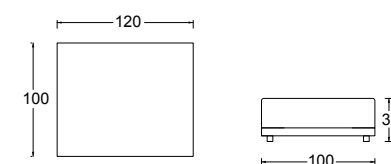

Descrizione Description	Codice Code	Lato Side	Tessuti - Fabrics				Pelle - Pelle			Tessuto cliente L./H. C.O.M. fabric L./H.
			Cat. B	Cat. C/D	Cat. Must	Cat. K	Cat. E	Cat. Plus	Cat. Luxury	
Espanso Foam	346CE8N 120x100									4,00/1,40
Fodera Cover										4,00/1,40

m³ 0,5 - kg. 22

Esempi di composizioni 1
Examples of arrangements 1

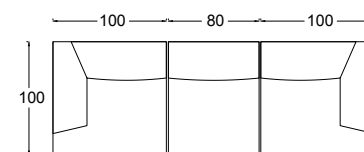

Descrizione Description	Codice Code	Lato Side	Tessuti - Fabrics				Pelle - Pelle			Tessuto cliente L./H. C.O.M. fabric L./H.
			Cat. B	Cat. C/D	Cat. Must	Cat. K	Cat. E	Cat. Plus	Cat. Luxury	
Espanso Foam	COMP. 1									10,50/1,40
Fodera Cover										

Codici elementi composizione
Codes of composition elements
346CE2S 100 (x2) + 346CE3N 80 (x1)

Esempi di composizioni 2
Examples of arrangements 2

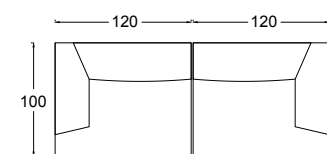

Descrizione Description	Codice Code	Lato Side	Tessuti - Fabrics				Pelle - Pelle			Tessuto cliente L./H. C.O.M. fabric L./H.
			Cat. B	Cat. C/D	Cat. Must	Cat. K	Cat. E	Cat. Plus	Cat. Luxury	
Espanso Foam	COMP. 2									13,00/1,40
Fodera Cover										

Codici elementi composizione
Codes of composition elements
346CE2S 120 (x2)